

# ATR833-II

## VHF Communication Transceiver



OLED P/N 833-II-(C0xx)-(C0xx)

LCD P/N 833-II-(C0xx)-(C1xx)

## Operation and Installation

(Document-Nr. 01.143.010.71e)



### Change History

Revision	Date	Description of Change
1.00	07.06.2017	First Release OLED/LCD Head-SW 1.00 / NF-FW 2.00
1.01	29.06.2017	Separate setting for dynamic und standard microphones added
1.02	02.08.2017	Chapter 4.7.3. Cable plan BSKS833D-S removed - New document of the cable sets referenced
1.03	13.09.2017	Chapter 4.6.2. / 4.7.2. / .4.11.2. corrected
1.04	13.02.2018	Update for NF-Fw 3.00, Chap. 3.8 and 3.12 amended, Correction in Chap. 4.7.3.2
1.05	25.04.2018	Chap. 4.7.2 Pin assignment adapted to modified Hw, Chap. 3.6 and 4.6.1 newly described

### List of Service Bulletins (SB)

Service-Bulletins are to be inserted in the manual and to be recorded in this table

SB Number	Rev. No.	Date of Issue	Entry Date	Name

# CONTENT

<b>1</b>	<b>GENERAL</b> .....	<b>5</b>
1.1	SYMBOLS .....	5
1.2	ABBREVIATIONS .....	5
1.3	CUSTOMER SUPPORT .....	6
1.4	EQUIPMENT CHARACTERISTICS.....	6
<b>2</b>	<b>OPERATION</b> .....	<b>7</b>
2.1	OVERVIEW OF CONTROLS.....	7
2.2	ON/OFF - COMMISSIONING .....	8
2.3	DISPLAY.....	9
2.4	FREQUENCY SETTING.....	11
2.4.1	<i>Automatic Selection 8.33 / 25 kHz Channel Bandwidth</i> .....	11
2.4.2	<i>Manual Frequency Input</i> .....	12
2.4.3	<i>Recall a Frequency from the User Memory</i> .....	13
2.4.4	<i>Recall a Frequency from the List of the 10 Last Used</i> .....	14
2.4.5	<i>Storage of a Frequency into the User Memory</i> .....	15
2.4.6	<i>ATR Frequency Tool</i> .....	16
2.5	BASIC SETTINGS .....	17
2.5.1	<i>VOL – Volume</i> .....	17
2.5.2	<i>SQL – Squelch (noise barrier)</i> .....	18
2.5.3	<i>VOX –Voice Activated Intercom</i> .....	19
2.5.4	<i>INT – Volume Intercom</i> .....	19
2.5.5	<i>STL – Volume Sidetone Left</i> .....	20
2.5.6	<i>STR – Volume Sidetone Right</i> .....	20
2.5.7	<i>EXT – Volume of the external Audio Input</i> .....	21
2.5.8	<i>BRT – Brightness</i> .....	21
2.5.9	<i>CON – Contrast</i> .....	22
2.6	TRANSMISSION .....	22
2.7	RECEPTION.....	23
2.8	REPLAY FUNKTION .....	24
2.9	DUAL WATCH OPERATION .....	24
<b>3</b>	<b>CONFIGURATION</b> .....	<b>26</b>
3.1	SPACING – CHANNEL SPACING .....	27
3.2	DISPLAY – ENERGY SAVING MODE (AUTOMATIC DISPLAY DARKENING).....	27
3.3	PTT SELECT - BUTTON SELECTION .....	28
3.4	DUOWATCH – DUAL-WATCH VOLUME REDUCTION.....	30
3.5	EXTAUDIO – BEHAVIOUR OF EXTERNAL AUDIO INPUT .....	30
3.6	MIC TYPE – SELECTION MIKROPHONE TYPE.....	32
3.7	MIC LEFT / RIGHT – MICROPHONE INPUT SENSITIVITY .....	32
3.8	HEAD OUT – HEADSET CONFIGURATION.....	34
3.9	AUTO ON – POWER-UP BEHAVIOR.....	35
3.10	FW /SW – FIRMWARE / SOFTWARE VERSION .....	35
3.11	MASTER RESET – RESET TO FACTORY SETTINGS.....	36
3.12	ADAPTER OPERATION.....	36
3.13	OVERVIEW CONFIGURATION MENU (SETUP) .....	37

---

<b>4</b>	<b>INSTALLATION.....</b>	<b>38</b>
4.1	ADVICE AND TIPS.....	38
4.2	TELECOMMUNICATION DATA.....	38
4.3	SCOPE OF DELIVERY .....	38
4.4	UNPACKING AND INSPECTING THE EQUIPMENT .....	38
4.5	MOUNTING.....	39
4.6	EQUIPMENT CONNECTIONS .....	39
4.6.1	<i>Microphone Connection .....</i>	<i>40</i>
4.6.2	<i>Headset-Connection .....</i>	<i>40</i>
4.6.3	<i>Audio-Input .....</i>	<i>40</i>
4.7	WIRING.....	40
4.7.1	<i>Conductor Cross Section .....</i>	<i>40</i>
4.7.2	<i>Connector – Pin Allocation .....</i>	<i>41</i>
4.7.3	<i>Wiring with Cable Harness BSKS833x-S.....</i>	<i>43</i>
4.8	ANTENNA .....	45
4.8.1	<i>Antenna Selection .....</i>	<i>45</i>
4.8.2	<i>Installation Recommendation .....</i>	<i>45</i>
4.9	MICROPHONE / INTERCOM SETTINGS .....	46
4.10	POST-INSTALLATION CHECK.....	46
4.11	DRAWINGS.....	47
4.11.1	<i>Dimensions .....</i>	<i>47</i>
4.11.2	<i>Mounting Advices.....</i>	<i>48</i>
<b>5</b>	<b>APPENDIX .....</b>	<b>49</b>
5.1	FREQUENCY/CHANNEL-PLAN.....	49
5.2	TECHNICAL DATA .....	50
5.3	ENVIRONMENTAL CONDITIONS.....	52

## 1 GENERAL

This manual contains information about the physical, mechanical and electrical characteristics, as well as information about installation and operation of the aeronautical VHF voice radio ATR833-II. The radio is available with LCD or OLED display.

### 1.1 Symbols

	Advices whose non-observance can cause radiation damage to the human body or ignition of combustible materials.
---	---

	Advices whose non-observance can cause damage to the device or other parts of the equipment.
---	--

	Information
---	-------------

### 1.2 Abbreviations

Abb.	Name / Subject	Definition
BRT	Brightness	Display Brightness
EXT	External Audio Input	Volume of external audio input
INT	Intercom	Volume of board-internal intercom
MIC	Microphone	Sensitivity of Microphone
PTT	Push-To-Talk	Button to activate radio transmission
SEL	Selection	Selection of value or function
SQ	Squelch	Noise suppression radio reception
VOL	Volume	Volume of radio reception
VOX	Voice activation	Volume threshold for voice-activated intercom

### 1.3 Customer Support

In order to facilitate a rapid return of shipments in case of repairs, please follow the instructions of the input guide “Reshipment RMA” provided at the Service-Area within the f.u.n.k.e. AVIONICS GmbH web portal [www.funkeavionics.com](http://www.funkeavionics.com).



Any suggestions for improvement of our manuals are welcome. Contact: [service@funkeavionics.com](mailto:service@funkeavionics.com).



Information on software updates is available at f.u.n.k.e. Avionics GmbH.

### 1.4 Equipment Characteristics

- VHF communication transceiver with 6W output power in 2 ¼” format
- Frequency range 118,000 to 136,975 MHz
- 2 microphone inputs (auto detection standard or dynamic)
- Voice controlled intercom for up to 4 microphones, can be deactivated for use with an external intercom
- Dual-watch technology, simultaneous monitoring of two frequencies
- Auxiliary audio input
- Memory for 20 user-definable named frequencies
- Easy recall of the 10 last used frequencies
- High contrast LCD / OLED display 128x64 dot matrix
- Wide range power supply 11 – 30 VDC
- Configurable energy saving mode



To avoid unintentional permanent transmission, the transmitter automatically stops transmission after 35 seconds of uninterrupted operation.

## 2 OPERATION

### 2.1 Overview of Controls



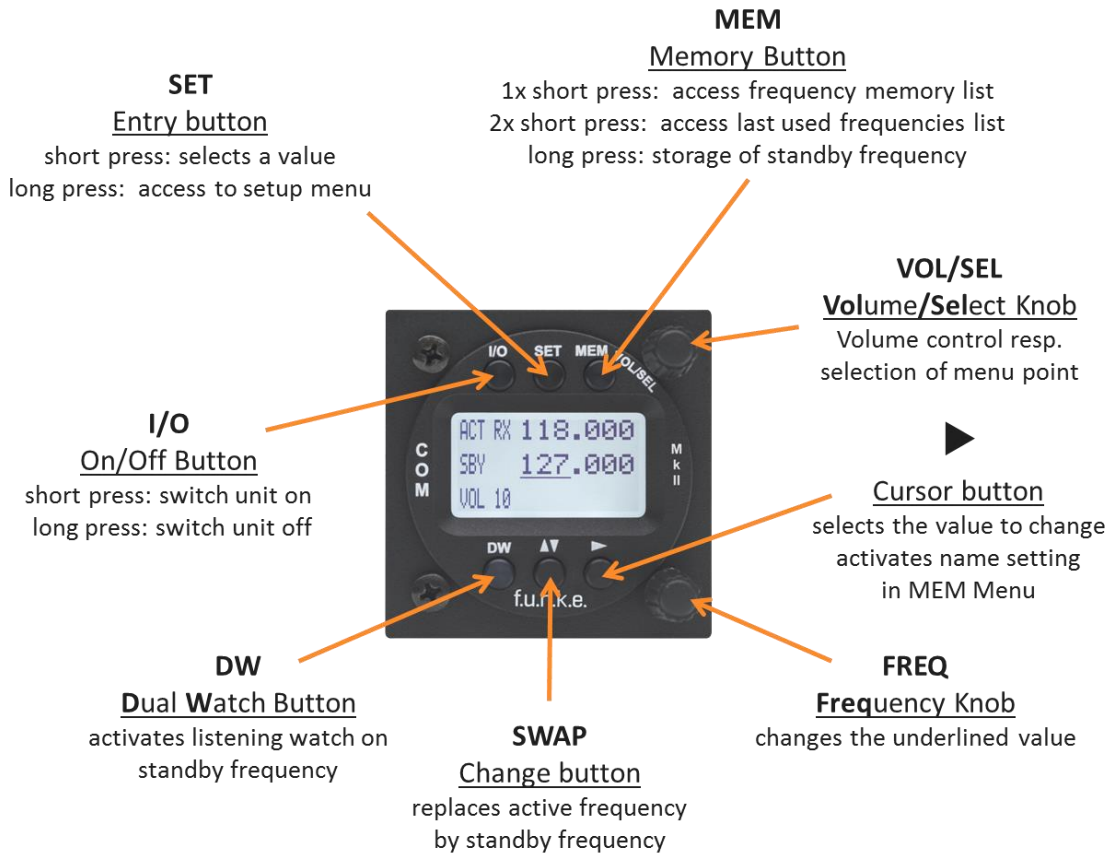

Position and naming of control elements:



The control elements have following functionality:

<b>I/O</b>	<b>ON/OFF</b>	Switch On press button for appr. 0,5 s Swich Off press button for appr. 3 s
<b>DW</b>	<b>DUAL WATCH</b>	Activates/deactivates the mode for mutual reception of standby frequency (display shows DW instead of SBY)
<b>SET</b>	<b>EINGABE</b>	1. Navigation through the standard menu (VOL, SQL, VOX, etc.) (adjustment of value with VOL/SEL, short press of SET for next value) 2. Access to setup menu → Press button for min. 5 seconds 3. Navigation through the setup menu (Spacing, backlight, DW Mute, PTT Select,..)



	CURSOR	<ol style="list-style-type: none"> <li>1. Marking (underline) of value for adjustment; value changeable with FRQ or VOL/SEL → Enter and continue with Cursor Button  short press</li> <li>2. Activates in MEM menu the entry of names</li> <li>3. Long press (&gt;2s) activates Replay</li> </ol>
	SWAP	Changes Active with Standby-Frequency
<b>MEM</b>	Memory	Access to frequency list (MEM-List) → press button shortly once
		Access list of 10 last used frequencies (LST-List) → press button shortly twice
		Stores Standby frequency to selected memory (in MEM-List) → press button for 2 seconds
 VOL/SEL	<b>VOL/SEL</b> Turn knob	<ol style="list-style-type: none"> <li>1. Adjust volume or other item selected by <b>SET</b> (VOL, SQ, VOX, DIM etc.)</li> <li>2. Select frequency from user memory or list of last used frequencies</li> </ol>
 FREQ	<b>FREQ</b> Turn knob	Change the underlined value (i.e. adjust standby frequency, or input character when entering name)

## 2.2 ON/OFF - Commissioning

Turn the device on with **I/O**.

Switch On: **I/O** press for appr. 0.5 seconds

Switch Off: **I/O** press for appr. 3 seconds

After turning on, following information appears on the display:

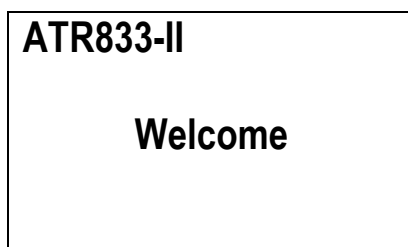

The start screen indicates device type and software version. After that screen the device changes into normal operation (direct input mode).

The radio starts with the same frequencies and settings from before being switched off.

## 2.3 Display

The ATR833-II shows the frequencies and the operating condition on a matrix LCD display with 128 x 64 pixels.

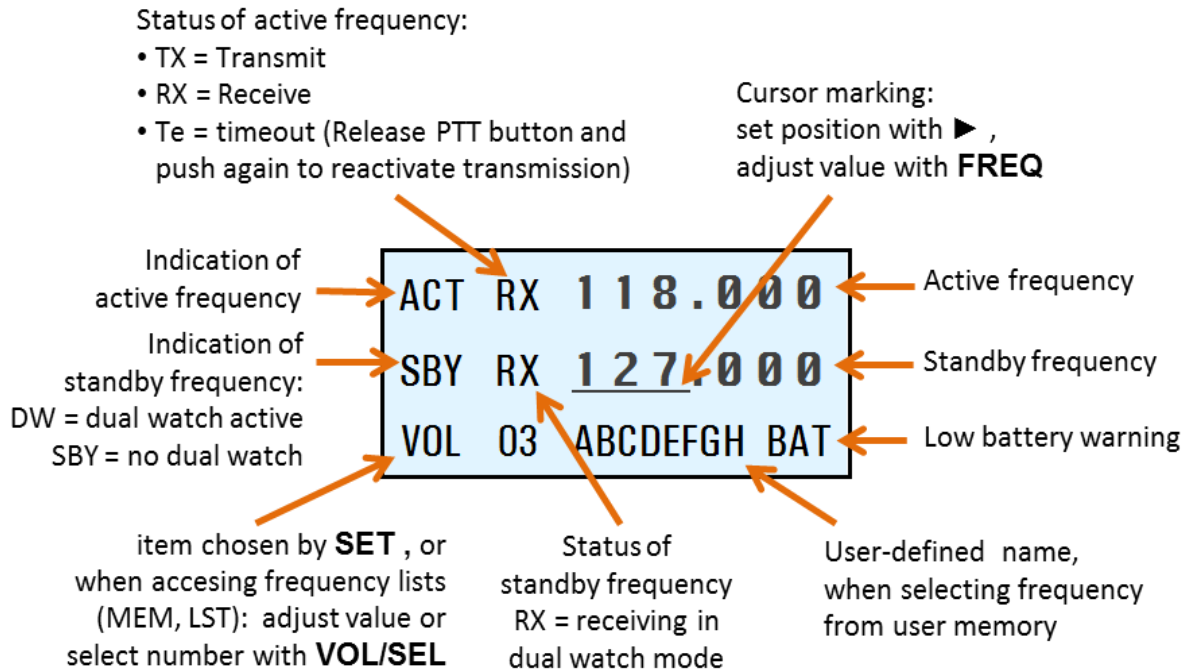

Display	Meaning	Remark
ACT	Fixed label for active frequency	
SBY	Label for standby frequency, when dual watch is not activated	Dual watch mode allows intermittent monitoring of standby frequency activity
DW	Label for standby frequency, when dual watch mode is activated	Dual watch mode allows intermittent monitoring of standby frequency activity
118.000	Active Frequency	Frequency used for transmissions and receptions
124.910	Standby frequency	May be monitored in dual watch mode
RX	Receiving on this frequency	Usually on active frequency; can also happen on standby frequency when DW is activated
TX	Transmitting on active frequency	PTT pressed

Display	Meaning	Remark
Te	Transmission ended automatically after 35 seconds of continuous transmission	Release PTT shortly and press again to re-enable transmission.
VOL 03	Volume level for receiving (standard display)	If SEL was pressed, the appropriate value of the standard menu are displayed at this position (see 2.4)
SQL 03	Squelch level	Radio signal strength threshold required for reception; suppresses noise and weak/distant transmitter
DISPLAY on	Timer for backlight resp. display brightness	Activates energy saving mode
VOX 05	VOX threshold	Speech level that activates the intercom
DUOWATCH -2	Dual Watch Mute	Reduction in volume for dual-watch-reception on standby frequency
INT 04	Intercom - Volume	
EXT 02	Volume of external audio signals	Set to 00, if no external device is connected, to prevent noise pickup
BRT 07	Brightness of display	
CON 05	Contrast of display	only for LCD
MEM 00	Item from user defined frequency list	Substitutes Standby Frequency; Active frequency can be stored into this entry with long press on <b>MEM</b>
LST 00	Item from list of last used frequencies	Substitutes standby /active frequency with press of <b>SET</b> / ▼▲ button.
ABCDEFGH	User-defined name in the frequency list	Displayed while selecting from user memory, when the user has assigned a name.
BAT	Very low supply voltage	Transmission only with reduced power possible (decreased radio range!)
>>REPLAY>>	Playback radio call	Replays the last radio call (max. 9 seconds)

## 2.4 Frequency Setting

Frequency setting is always done by the two steps of

1. Entering a new standby frequency to the desired value, and then
2. Interchanging the new standby frequency and the previous active frequency by using the swap button ▼▲.

Entering a new standby frequency can be done by

- a) Manual input,
- b) Recall of previously stored frequencies from the user memory (memory locations 1-20), or
- c) Recall from the list of the last 10 used frequencies.

### 2.4.1 Automatic Selection 8.33 / 25 kHz Channel Bandwidth

Whether a frequency is used with channel width 8.33 kHz or 25 kHz, is automatically determined by the value of the frequency entered, and requires no additional user activity.

The numbering scheme that is used for distinction of the two channel widths is internationally standardized by the ICAO, and consistently used in official documents (like e.g. VFR navigation charts) as well as in the voice phraseology used by ATC radio communication.

Channels used with 25 kHz width are entered in multiples of 25kHz: 123.500, 123.525, 123.550, 123.575, 123.600 etc. These are compatible with the old 25 kHz-only radios. To use the same frequencies with 8.33 kHz width, the frequency values entered are increased by 5kHz: 123.505, 123.530, 123.555, 123.580, 123.605 etc.

For more detailed information please refer to chapter 5.1 – but as said above, for correct channel width selection this knowledge is not required.

## 2.4.2 Manual Frequency Input

The standby frequency is input by

- Selecting with the ► button which part of the frequency to change, and
- Changing the selected part with the **FREQ** rotary knob.

The swap button ▼▲ interchanges the newly set standby frequency and the former active frequency.



In order to speed up the entering of new frequencies, it is possible to configure the radio to allow entering of those frequencies only that are used with 25 kHz channel width.

Please refer to chapter 3.1 for information on this configuration.

However, when choosing this option, please keep in mind to re-enable 8.33 kHz channel selection before flying into areas where 8.33 kHz channels are used.

When having the channel selection configured for 8.33 kHz steps (see 0), the frequency is input in three steps:

SBY	<u>118</u> . 910
-----	------------------



SBY	118 . <u>910</u>
-----	------------------



SBY	118 . 9 <u>10</u>
-----	-------------------

### 2.4.3 Recall a Frequency from the User Memory

To access the user memory frequency list, press **MEM** once, and select one of the 20 memory entries with the **VOL/SEL** turn knob.

The selected memory entry is shown instead of the standby frequency.

In the lower row of the display, the number of the memory entry selected is indicated by [MEM xx] (with xx = 1 to 20); if a name has been provided by the user for this memory entry, it is displayed next to the memory entry number.

ACT		1	2	3	.	4	5	0
SBY		1	1	8	.	2	7	5
MEM	2							

↪ Range: 01 - 20

Repectively:

ACT		1	2	3	.	4	5	0
SBY		1	1	8	.	2	7	5
MEM	2	E	D	N	E			

A push on the swap button ▼▲ replaces the Active Frequency, a press on the **SET** button the Standby Frequency with the selected list entry.

If no input is done for 10 seconds, the device returns to the standard view, too.

### 2.4.4 Recall a Frequency from the List of the 10 Last Used

The radio automatically keeps track of the last 10 used active frequencies. To access this list, press **MEM** twice, and select one of the 10 list entries with the **VOL/SEL** turn knob. The selected memory entry substitutes the former standby frequency.

The number of the selected list entry is given in the display's lower row.

ACT	1	2	3	.	4	5	0
SBY	1	1	8	.	2	7	5
LST	2						

↵ Range: 1 - 10

Respectively:

ACT	1	2	3	.	4	5	0
SBY	1	1	8	.	2	7	5
LST	2	E	D	N	E		

↵ ↵ ↵ ↵ ↵ ↵ ↵ ↵ ↵ 8 digits A-Z, 0-9

	List entry "1" contains the last standby frequency from the MEM menu.
---	---

If there is no input for 10 seconds, the device returns to the standard view.

### 2.4.5 Storage of a Frequency into the User Memory

The active frequency can be stored into any entry of the user memory.

This is achieved by a long press of 1,5 seconds on **MEM**. The previous memory entry will be overwritten.

The following example stores the frequency 124.350 MHz of KONSTANZ (EDTZ) into the user memory 7:

Step	Display (example)
1. <u>Tune in frequency:</u> Have frequency to be stored set as standby frequency	<div style="border: 1px solid black; padding: 5px;">             ACT    <b>118 . 275</b>              SBY    <b>124 . 350</b>              VOL 05           </div>
2. <u>Enter memory list:</u> With a long press on <b>MEM</b> the frequency can be stored to the user memory.	<div style="border: 1px solid black; padding: 5px;">             ACT    <b>118 . 275</b>              SBY    <b>124 . 350</b>              MEM    saveTo    1           </div>
3. <u>Select memory position:</u> Selection of the decided memory position with <b>VOL/SEL</b>	<div style="border: 1px solid black; padding: 5px;">             ACT    <b>118 . 275</b>              SBY    <b>124 . 350</b>              MEM    saveTo    7           </div>
4. <u>Overwrite the selected memory :</u> With a <b>short press</b> of <b>MEM</b> the standby frequency is stored at the selected position.  A preceding <b>&gt;</b> shows the successful storage to the memory position.	<div style="border: 1px solid black; padding: 5px;">             ACT    <b>118 . 275</b>              SBY    <b>&gt; 124 . 350</b>              MEM                7           </div>



To exit the frequency list, press **DW** or wait 10 seconds until time-out.

To every frequency entry a name can be assigned with up to 8 characters, which is shown right of the entry.

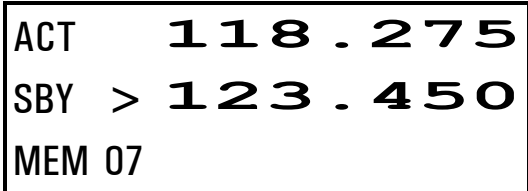
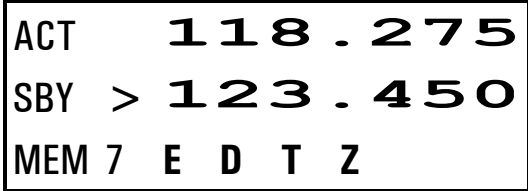
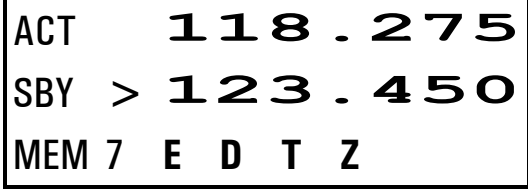
<p>To assign a name to a memory entry, the appropriate entry must be selected. The next steps follow directly step 4 from above.</p> <p>5. <u>Change of name entry:</u>          A long press of the Cursor button ► enables the entry of a name</p>	
<p>6. <u>Enter the name:</u>          By changing the selected character with <b>FREQ</b>, and advancing the selection with ►, just as when manually entering a standby frequency.</p>	
<p>7. <u>Store the name:</u>          The new entry is either stored with a long press of <b>MEM</b> or by a short press on the Cursor button ►.</p>	

To exit the frequency list press the **SET** button or wait 10 seconds until time-out.

### 2.4.6 ATR Frequency Tool

The ATR Frequency Tool from Version 1.3 supports the ATR833-II. With the tool the frequency memory of the ATR833-II can be managed, i.e. frequencies can be added, edited and deleted. The frequency list can be stored as a file.

The ATR Frequency Tool can be downloaded from the f.u.n.k.e. AVIONICS homepage in the service area under Info / Download.

## 2.5 Basic Settings

To choose between the following settings, use the **SET** button:

1. VOL Volume (chosen by default)
2. SQL Squelch (noise suppression)
3. VOX Voice Activated Intercom  
(speech level required to activate the intercom)
4. INT Volume Intercom
5. STL Volume Sidetone left
6. STR Volume Sidetone right
7. EXT Volume of external audio signals
8. BRT Display brightness
9. CON Display contrast (only for devices with LCD)
- ... back to Volume

The return to the default display (VOL) is carried out by a short press on the Dualwatch button **DW** or happens automatically after 10 seconds of inactivity.

The chosen setting can be adjusted by the **VOL/SEL** rotary knob.

### 2.5.1 VOL – Volume

The radio returns automatically to the volume setting, when a value has been set with the VOL/SEL turn knob.

Turning the **VOL/SEL** knob adjusts the volume of received radio signals. The higher the value, the louder the reception of radio signals.

ACT	1	2	3	.	4	5	0
SBY	1	1	8	.	2	7	5
VOL	2						

↪ Range: 1 – 20



The VOL setting controls the volume of received radio signals only, not the volume of the intercom or the external audio input – these are set separately with INT and EXT.

### 2.5.2 SQL – Squelch (noise barrier)

By shortly pressing the **SET** key once, with the help of the rotary knob the squelch level can be adjusted. (Note: This is not related in any way to the intercom functionality.)

This is a threshold that has to be exceeded by radio signal levels from other transmitters, in order to activate the reception circuitry. The higher the number, the stronger the radio signals have to be in order to be received.

ACT	1	2	3	.	4	5	0
SBY	1	1	8	.	2	7	5
SQL	2						

↵ Range: 0 - 9

The setting for the squelch depends on different factors. For motor aircrafts an initial higher setting is typically appropriate, gliders may use a lower value. A lower number means higher input sensitivity.

This allows reception of weaker signals (radio stations at higher distance), but can also result in pickup of own-aircraft radio interference sources (engine, strobe lights).



The default squelch setting is 05. At higher values weak signals could be suppressed.

### 2.5.3 VOX –Voice Activated Intercom

By shortly pressing the **SET** key twice, with the help of the rotary knob, the threshold volume **VOX** for intercom voice detection can be adjusted. (Note: This is not related in any way to radio reception or squelch.)

**VOX** defines the crew's speech volume that is required to activate the intercom functionality. The higher the value, the louder you need to speak in order to activate the intercom.

Exception: VOX 0 corresponds to "always on"

ACT		<b>1</b>	<b>2</b>	<b>3</b>	<b>.</b>	<b>4</b>	<b>5</b>	<b>0</b>
SBY		<b>1</b>	<b>1</b>	<b>8</b>	<b>.</b>	<b>2</b>	<b>7</b>	<b>5</b>
VOX	<b>3</b>							

↪ Range: Off, 1 - 9

In case of very noisy backgrounds or use of uncompensated microphones, the automatic VOX functionality may not work satisfyingly.

In these cases, it is possible to deactivate the VOX automatism with VOX: 0, and to use an external intercom-switch.

### 2.5.4 INT – Volume Intercom

By pressing three times the SET button, the volume of the intercom can be adjusted with the VOL/SEL turn knob.

The intercom functionality is the onboard crew-internal communication for multi-seater aircraft. A change in the intercom volume level also changes the volume of the sidetone. The sidetone is an audible feedback of the own voice to the headset, i.e. you hear yourself speak. This feature supports a natural speech behavior.

The intercom can be activated in two ways:

- Automatically, i.e. whenever someone speaks into a microphone (i.e. voice activated intercom = VOX, see chapter 0).
- Manually, i.e. by use of an external intercom switch.

ACT		1	2	3	.	4	5	0
SBY		1	1	8	.	2	7	5
INT	3							

↵ Range: 0 - 20

### 2.5.5 STL – Volume Sidetone Left

The sidetone is a self-hearing or back-hearing function during transmission. The audio signal picked up by the microphone is fed directly to the headset, which is normally perceived as pleasant. In this menu point the volume of the sidetone for the left seat can be adjusted.

ACT		1	2	3	.	4	5	0
SBY		1	1	8	.	2	7	5
STL	4							

↵ Range: 0 - 20

### 2.5.6 STR – Volume Sidetone Right

By pressing the **SET** button five times you get access to the STR menu. Here the volume of the sidetone for the right seat can be adjusted.

ACT		1	2	3	.	4	5	0
SBY		1	1	8	.	2	7	5
STR	4							

↵ Range: 0 - 20

### 2.5.7 EXT – Volume of the external Audio Input

By shortly pressing the **SET** key six times, the volume of external audio signals (warning tones, music, etc. ...) can be controlled with the rotary knob.

The higher the value, the higher is the volume of the external audio signal. A value of **EXT = 0** deactivates the external audio input.

ACT	1	2	3	.	4	5	0
SBY	1	1	8	.	2	7	5
EXT	5						

↪ Range: Off, 1 - 20



When no other device is connected to the external audio input, the input should be muted by selecting 00, in order to prevent noise by pickup of on-board interferences.



The priority of the external audio input in comparison to radio receptions can be configured, see chapter 0)

### 2.5.8 BRT – Brightness

By pressing the **SET** seven times the brightness of the backlight of the LCD display can be adjusted with the VOL/SEL turn knob. For devices with an OLED display this function controls the brightness of the display.

ACT	1	2	3	.	4	5	0
SBY	1	1	8	.	2	7	5
BRT	5						

↪ Range: 0 - 9

### 2.5.9 CON – Contrast

By pressing the **SET** eight times the last configuration item is reached in the standard menu, where the contrast of the display can be adjusted with the **VOL/SEL** turn knob.

ACT		<b>1 2 3 . 4 5 0</b>
SBY		<b>1 1 8 . 2 7 5</b>
CON	5	

↵ Range: 0 - 9



The menu point “CON” is only available for radios with LCD display. This setting is missing for devices with an OLED display.

## 2.6 Transmission

By pushing the PTT button, the device starts transmission on the active frequency. The operation of the transmission is indicated by “TX” in front of the frequency used.

ACT	<b>TX</b>	<b>1 2 3 . 4 5 0</b>
SBY		<b>1 1 8 . 2 7 5</b>
VOL	5	

In order to avoid unintended transmissions, e.g. when having the PTT button stuck (“stuck mic”), the transmitter automatically stops after 35 ±5 seconds of transmission, and „TX“ is substituted by „Te“.

ACT	Te	<b>1 2 3 . 4 5 0</b>
SBY		<b>1 1 8 . 2 7 5</b>
VOL	5	

In order to re-enable transmission in this case, release PTT and push it again.



When having more than one PTT button and microphone equipped, it can be configured (chapter 3.3) to use only one PTT button for transmissions.

## 2.7 Reception

When receiving, a „RX“ is shown in front of the active frequency.

ACT	RX	<b>1 2 3 . 4 5 0</b>
SBY		<b>1 1 8 . 2 7 5</b>
VOL	5	

When having dual watch active (see 0) RX can be shown on the standby frequency, too.

ACT		<b>1 2 3 . 4 5 0</b>
DW	RX	<b>1 1 8 . 2 7 5</b>
VOL	5	



## 2.8 REPLAY Funktion

The ATR833-II automatically stores the last 9 seconds of an incoming radio call. Pressing the CURSOR key ► will play the last received radio message. The display will show » R E P L A Y » for the duration of the playback.

ACT		1 2 3 . 4 5 0
DW		1 1 8 . 2 7 5
VOL	5	>> R E P L A Y >>

As long as a radio call is received, the REPLAY function is deactivated. This also means that the squelch setting must not be zero.

## 2.9 DUAL WATCH Operation

The ATR833-II comprises one receiver; therefore “dual watch” (simultaneously monitoring two frequencies) is implemented by alternating automatically between the active and the standby frequency.

With dual watch mode active, basically the standby frequency is tuned in, shortly interrupted in regular intervals by tuning in the active frequency for a fraction of a second.

Every then detected radio signal on the active frequency has priority, and pauses the dual watch monitoring of the standby frequency, as long as the reception/transmission continues on the active frequency.

Transmissions are always done on the active frequency.

The dual watch mode is activated by pressing **DW**, and indicated by a changing the “**SBY**” label for the standby frequency to “**DW**”.

ACT	RX	1 2 3 . 4 5 0
DW		1 1 8 . 2 7 5
VOL	5	

The dual watch mode is deactivated by pressing **DW** again, and by any operations changing either of the frequencies.



SQL has to be set to 01 at least, as without adequate squelch functionality the radio is not able to detect if there is a reception on the active frequency.

In order to have an audible distinction between receptions on the active and the standby frequency, it is possible to hear the receptions from the standby frequency with a lower volume. Please refer to chapter 0. for information about the feature “dual watch volume reduction”.

Quick approach:

- Select or enter a standby frequency which shall be additionally monitored.
- Set **SQL** with the **SET** button and the rotary knob to a value of at least 01.
- Activate dual watch with **DW** (**DW** is shown)
- As soon as no reception is determined on the active frequency, the mutual monitoring between active and standby frequency starts.
- In order to deactivate dual watch: press **DW** once more or change the frequency.



Don't forget to interchange the active and standby frequencies, before answering a call on the standby frequency.

### 3 CONFIGURATION

A very long press of **SET** (5 seconds) accesses the configuration menu. The configuration menu is used for fundamental settings.

To choose between the following settings, use the **SET** button:

1. SPACING           Channel spacing
2. DISPLAY           Display darkening (power save mode)
3. PTT SLCT         PTT button selection
4. DUOWATCH        Dual Watch muting
5. EXTAUDIO         Behaviour of the external audio input
6. MICL TYP         Microphone type left
7. MICL std         Microphone sensitivity left (for standard mic.)
8. MICL dyn         Microphone sensitivity left (for dynamic mic.)
9. MICR TYP         Microphone type right
10. MICR std         Microphone sensitivity right (for standard mic.)
11. MICR dyn         Microphone sensitivity right (for dynamic mic.)
12. HEAD OUT        Headset configuration
13. AUTO ON         Automatic power on with cockpit power
14. FW               Firmware version (Processor)
15. SW               Software version (Control Head)

Return to the standard mode (**VOL**) is done by a short press of the **I/O**, **DW**, **▼▲** or **▶** button or automatically 10 seconds after the last entry (time-out).

The selection of the values is done with **VOL/SEL** turn knob.

### 3.1 SPACING – Channel Spacing

With this setting, the ATR833 can be configured to constrain frequency selection to 25 kHz channels only. This can be used to speed up the manual frequency input in areas where no 8.33 kHz channel spacing is used.

See chapter 2.4.2 for further information on manual frequency input.

Using the **VOL/SEL** turn knob following options can be selected in this submenu:

**8.33 kHz:** allows input of both 8.33 kHz and 25 kHz channels

ACT	RX	1	2	3	.	4	5	0
SBY		1	1	8	.	2	7	5
SPACING								8.33kHz

**25 kHz:** allows input of 25 kHz channels only

ACT	RX	1	2	3	.	4	5	0
SBY		1	1	8	.	2	7	5
SPACING								25kHz

A short press of SET switches to the next configuration item.



Please keep in mind to enable 8.33 kHz channel selection before flying into areas where this channel spacing is mandatory.

### 3.2 DISPLAY – Energy Saving Mode (Automatic Display Darkening)

In order to minimize power consumption the backlight of the LCD display can be switched off after a selectable time period, respectively the brightness of the OLED display is reduced.

With the **VOL/SEL** turn knob following options can be selected:

**always on:** no display darkening at all

ACT	RX	1 2 3 . 4 5 0
SBY		1 1 8 . 2 7 5
DISPLAY		ever on

**off xxx s:** automatic display darkening after xxx seconds after last user interaction (xxx= 10s, 20s, 30s, 60s, 120s)

ACT	RX	1 2 3 . 4 5 0
SBY		1 1 8 . 2 7 5
DISPLAY		off 10s

Reactivation of the darkened display is done by press of any key (except key **I/O**) or turn of any knob (the action of the key pressed is performed when pressing the key again after the display turned on) or when transmitting.

A short press of **SET** switches to the next configuration item.

	<p>This feature should only be used when:</p> <ul style="list-style-type: none"> <li>• it can be foreseen that no frequency changes will be required (i.e. when using only limited airspace near one airport, e.g. for circuit pattern training flights), and</li> <li>• the crew is familiar with the energy saving mode</li> </ul> <p>In all other cases this feature shall be deactivated, in order to prevent the usage of wrong frequencies and to avoid confusion of pilots not aware of the energy saving mode.</p>
---	--

### 3.3 PTT SELECT - Button Selection

In case of using two external PTT buttons, this configuration item can be used to deactivate one PTT button – and the associated microphone(s) – from enabling transmission.

With the **VOL/SEL** rotary knob the following options can be selected:

**all mics:** both PTT buttons and all microphones are used for transmissions, no matter what PTT button was pressed.

ACT RX	<b>1 2 3 . 4 5 0</b>
SBY	<b>1 1 8 . 2 7 5</b>
PTT SLCT	all mics

**one mic:** according to the PTT button pressed, the associated microphone is activated

ACT RX	<b>1 2 3 . 4 5 0</b>
SBY	<b>1 1 8 . 2 7 5</b>
PTT SLCT	one mic

**left only:** only the left PTT button and the left microphone(s) are used for transmissions

ACT RX	<b>1 2 3 . 4 5 0</b>
SBY	<b>1 1 8 . 2 7 5</b>
PTT SLCT	left

**right only:** only the right PTT button and the right microphone(s) are used for transmissions

ACT RX	<b>1 2 3 . 4 5 0</b>
SBY	<b>1 1 8 . 2 7 5</b>
PTT SLCT	right

The intercom functionality is not affected by this setting.

A short press of **SET** switches to the next configuration item.



When deactivating one PTT button and microphone for transmissions, e.g. in order to keep passengers from interfering with ATC communication, don't forget to reactivate the copilot's PTT after end of the flight.

### 3.4 DUOWATCH – Dual-Watch Volume Reduction

By shortly pressing the **SET** button four times, with help from the **VOL/SEL** rotary knob the lowering of the volume level (“mute”) for receptions on the standby frequency (when having dual watch active) can be controlled. This allows acoustic distinction between both frequencies.

For further information about the dual watch mode see 0.

ACT	RX	<b>1 2 3 . 4 5 0</b>
SBY		<b>1 1 8 . 2 7 5</b>
DUOWATCH		mute: -1

↪ Wertebereich - 9 - 0

Minus 9 is the strongest reduction, i.e. the dual watch reception is much quieter.

0 means no reduction, i.e. the dual watch reception is as loud as the reception on the active frequency.

### 3.5 EXTAUDIO – Behaviour of External Audio Input

The external audio input can be used to feed a monaural audio signal to the amplifier for the headsets/speaker.

An external audio signal can be used for different purposes. E.g. it is possible to check the audio signal of a VOR receiver, to attach a traffic sensor with acoustic output, or to use the external audio input for (monaural) music input.

As these signals have different priorities in comparison to radio receptions, the priority of the external audio input can be configured.

With the **VOL/SEL** rotary knob the following options can be selected:

**ever on:** The external audio input is always on, even during radio receptions and transmit mode. Use this setting only for very high priority acoustic warnings, e.g. collision warning beep tones.

ACT		<b>1 2 3 . 4 5 0</b>
SBY		<b>1 1 8 . 2 7 5</b>
EXTAUDIO		<b>ever on</b>

**auto off:** The external audio input is automatically deactivated during transmit mode, or when no external audio activity is sensed.

ACT		<b>1 2 3 . 4 5 0</b>
SBY		<b>1 1 8 . 2 7 5</b>
EXTAUDIO		<b>auto off</b>

**not RXTX:** The external audio input is automatically deactivated during radio receptions or transmit mode. This setting does not use the external audio activity sensing, and therefore can introduce noise when no signal source is connected.

ACT		<b>1 2 3 . 4 5 0</b>
SBY		<b>1 1 8 . 2 7 5</b>
EXTAUDIO		<b>not RxTx</b>



Use this setting only when auto off does not react fast enough for very short external audio signals!

A short press of **SET** switches to the next configuration item.



### 3.6 MIC TYPE – Selection Microphone Type

The next option in the configuration menu is the setting of the microphone type.

Selecting the microphone type switches the individual microphone inputs. With the setting "dynamic" the dynamic inputs MIC L dyn and MIC R dyn become active and the input for standard microphones is switched off. With the setting "standard" the inputs for standard microphones MIC L std. and MIC R std become active and the dynamic microphone inputs are deactivated. This avoids noise on unused inputs.

With setting "auto", a standard microphone works on the standard input or a dynamic microphone on the dynamic input.

If the dynamic microphone inputs are occupied, these are automatically activated and the standard inputs are switched off. If the dynamic microphones are deactivated via a switch, the standard microphone inputs are automatically activated.

ACT	RX	<b>1 2 3 . 4 5 0</b>
SBY		<b>1 1 8 . 2 7 5</b>
MICL TYPE		auto

↪ Range: auto, standard, dynamic

ACT	RX	<b>1 2 3 . 4 5 0</b>
SBY		<b>1 1 8 . 2 7 5</b>
MICR TYPE		standard

↪ Range: auto, standard, dynamic

### 3.7 MIC LEFT / RIGHT – Microphone Input Sensitivity

The last item in the configuration menu is the setting for the microphone sensitivity.

The sensitivity can be adjusted with the **VOL/SEL** turn knob. The sensitivity can be adjusted separately for the left and right microphone and for each type.

ACT		<b>1 2 3 . 4 5 0</b>
SBY		<b>1 1 8 . 2 7 5</b>
MICL std		sens: 6

↵ Range 0 – 9

ACT		<b>1 2 3 . 4 5 0</b>
SBY		<b>1 1 8 . 2 7 5</b>
MICL dyn		sens: 6

↵ Range 0 – 9

ACT	RX	<b>1 2 3 . 4 5 0</b>
SBY		<b>1 1 8 . 2 7 5</b>
MICR std		sens: 4

↵ Range 0 – 9

ACT	RX	<b>1 2 3 . 4 5 0</b>
SBY		<b>1 1 8 . 2 7 5</b>
MICR dyn		sens: 4

↵ Range 0 – 9

A short press on the **SET** button terminates the configuration menu.

### 3.8 HEAD OUT – Headset Configuration

The menu item HEAD OUT determines whether one headset output is used or whether both headset outputs are used for separate control.

ACT	RX	<b>1 2 3 . 4 5 0</b>
SBY		<b>1 1 8 . 2 7 5</b>
HEAD OUT		<b>one</b>

The setting "one" is required when operating the transceiver with an old harness (without extension -S in the cable name). Adjusting the volume of the sidetone during transmission is then carried out via the menu item STL (Sidetone Level) and controls both headphones. The menu item STR is hidden.

ACT	RX	<b>1 2 3 . 4 5 0</b>
SBY		<b>1 1 8 . 2 7 5</b>
HEAD OUT		<b>two</b>

The setting "two" is required for the separate setting of the sidetone (STL and STR) of the headphones and requires the separate connection of two headphones. Cable sets with the extension "-S" provide this separate connection.

### 3.9 AUTO ON – Power-Up Behavior

Under the menu item AUTO ON the switch-on behavior can be adjusted with the Avionic Master Switch.

When "on" is set, the radio will start as soon as the operating voltage is supplied to the unit.

ACT		<b>1 2 3 . 4 5 0</b>		
SBY		<b>1 1 8 . 2 7 5</b>		
AUTO ON		<b>on</b>		

If "off" is set, the device remains switched off when the voltage is applied, no matter how switched off.

ACT		<b>1 2 3 . 4 5 0</b>		
SBY		<b>1 1 8 . 2 7 5</b>		
AUTO ON		<b>off</b>		

### 3.10 FW /SW – Firmware / Software Version

The firmware or the software version of the device is displayed here. No settings are possible.

Display Firmware NF (example)

ACT		<b>1 2 3 . 4 5 0</b>		
SBY		<b>1 1 8 . 2 7 5</b>		
FW	<b>02.00</b>	<b>21136</b>		

Display Software Control Head (example)

ACT		<b>1 2 3 . 4 5 0</b>		
SBY		<b>1 1 8 . 2 7 5</b>		
SW	<b>01.00</b>	<b>21157</b>		

### 3.11 Master Reset – Reset to Factory Settings

With following procedure all configurations are reset to the factory settings. Switch of the device. Press MEM button and DW button and switch the unit on. Following screen appears after start-up:

Reset to defaults:	
	yes/NO

The master reset is activated by pushing the **SET** button. The reset is carried out by confirmation with the SET key and the radio restarts automatically.

Reset to defaults:	
	yes/NO

### 3.12 Adapter Operation

If the ATR833A-II is operated with an adapter for an older cable set, this adapter is automatically detected and the device is set into adapter mode. In adapter mode, the following settings are made automatically:

1. PTT Select is set to "all mics" because with "single mic" setting it might be that one microphone is not working. The "PTT Select" selection is therefore hidden in adapter mode.
2. Adjusting the volume of the sidetone during transmission is done via the menu STL and controls both headphones. The menu item STR is hidden. The intercom volume is adjusted via the INT setting and controls both headsets.

### 3.13 Overview Configuration Menu (Setup)

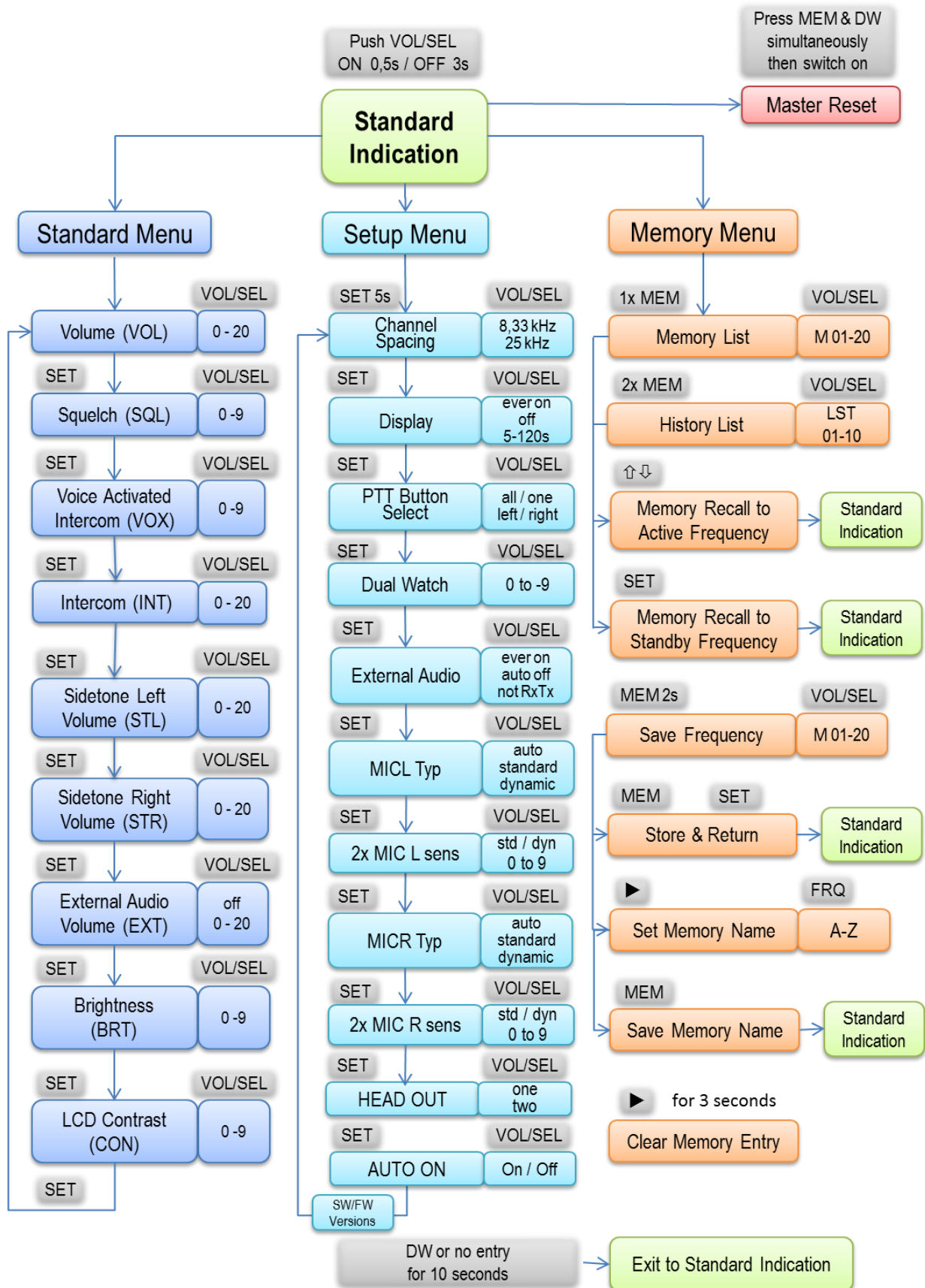

## 4 INSTALLATION

### 4.1 Advice and Tips

The following suggestions should be considered before installing  
The assigned installation company could perform wiring. For diagrams refer to chapter 0- Wiring.

### 4.2 Telecommunication Data

Manufacturer:	f.u.n.k.e. AVIONICS GmbH
Type Designation:	ATR833-II
EASA Number:	EASA.21O.10062108
Transmitter Power Output:	6 Watt
Frequency:	118,000 – 136,975 MHz
Emission Designator:	6k00A3E for 25khz channel spacing 5k00A3E for 8,33kHz channel spacing

### 4.3 Scope of Delivery

Part No.	Description
ATR833-II	ATR833-II – VHF communication transceiver
ZUB4	2 mounting screws and 2 hollow screws – for panels up to 3 mm.
SSATR2	Connector (Only if no cable set was ordered)
01.143.010.71e	User Manual „Operation and Installation“
	EASA Form 1

### 4.4 Unpacking and Inspecting the Equipment

Carefully unpack the equipment. Damages due to transportation must be reported to the shipping company immediately. Save the shipping container and all packing materials to substantiate your claim.



Please use the original packing material for storage and shipping.

## 4.5 Mounting

- In cooperation with a maintenance shop, location and kind of the installation are specified. The maintenance shop can supply all cables. Suitable sets of cables are available from f.u.n.k.e. AVIONICS GmbH.
- Select a position away from heat sources. Care for adequate convection cooling.
- Leave sufficient space for the installation of cables and connectors.
- Avoid sharp bends and wiring close to control cables.
- Leave sufficient lead length for inspection or repair of the wiring of the connector.
- Bend the harness at the rear connectors to inhibit water droplets (formed due to condensation) from collecting in the connector.
- Remove rotary knobs (2 pieces) before mounting:
  - Lift-off faceplate with an appropriate tool
  - Loosen screw and remove rotary knob
  - Insert cap correctly orientated!
- The equipment is fixed front-laterally with two 6mm hollow screws and two 4x8mm screws in a 2¼" cut-out.
- For mounting details/drawing refer to chapter 4.11.2

## 4.6 Equipment Connections

One 25 pin D-SUB miniature connector includes all electrical connections, except for the antenna.



The (+UB)-wire (PWR – Pin 11/12) has to be protected by a circuit breaker (4 Amp. slow-blow)!



### 4.6.1 Microphone Connection

The standard microphone inputs provide phantom power of 9V. The sensitivity can be set in the configuration menu (see chapter 3.7).

Standard microphones (headset) and dynamic microphones (hand / gooseneck) can be connected at the same time. With setting MIC type auto, the dynamic microphone connection has priority over the standard microphone.

### 4.6.2 Headset-Connection

Two headsets may be connected in parallel per input. In this case the total impedance shall not be less than 100  $\Omega$ .

### 4.6.3 Audio-Input

The external audio input can be used for the input of warn tones or music etc. In order to avoid disturbances while this input is not used, the respective wire needs to be short-circuited.

With cable sets available from f.u.n.k.e. Avionics the external audio-input is already short-circuited by a blind plug. This blind plug can be easily removed in order to use the external audio input.



If the external input is not used, it needs to be short-circuited with GND, in order to avoid the pickup of electrical noise.

## 4.7 Wiring

### 4.7.1 Conductor Cross Section

The conductors used must be approved for aircraft installation.

Power Supply (Power, GND):      AWG18 (0.96 mm<sup>2</sup>)

Signals:                              AWG22 (0.38 mm<sup>2</sup>)

#### 4.7.2 Connector – Pin Allocation

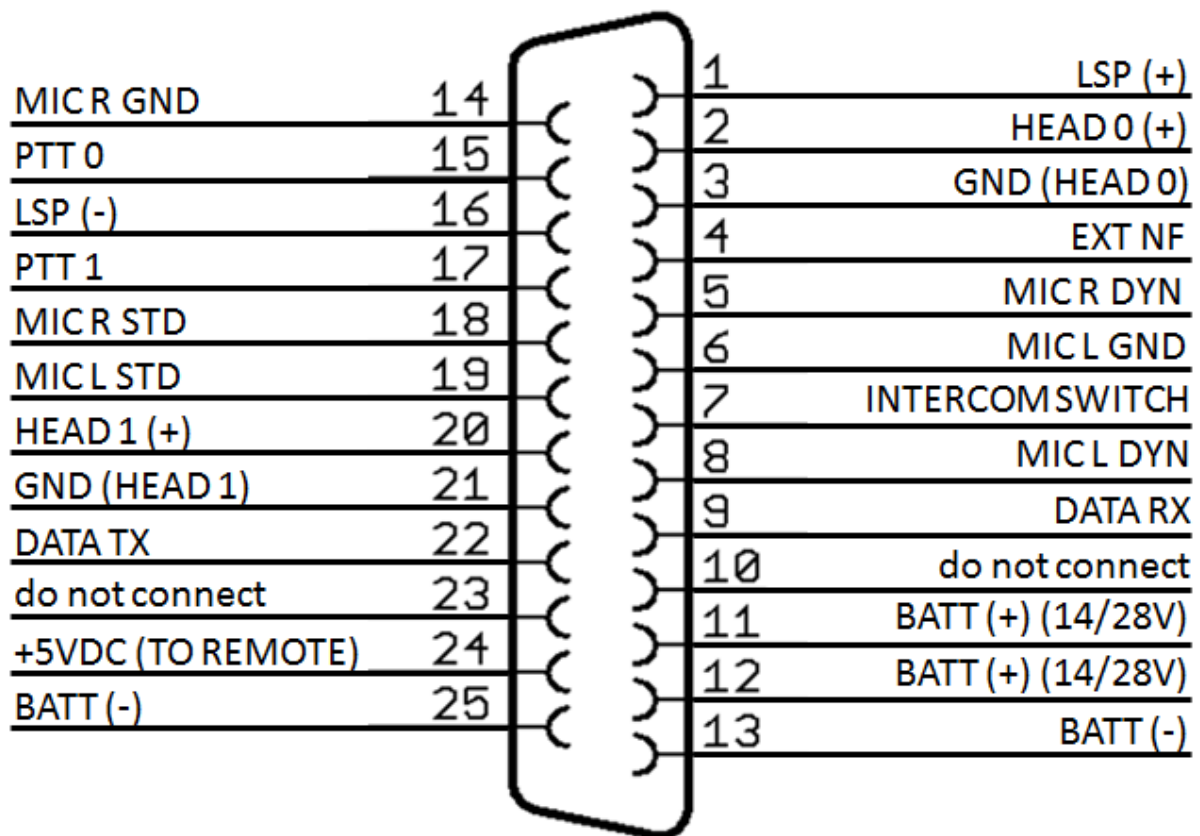

D-SUB Connector 25 Pin Female  
seen from solder side

Pin	Names	Functionality
1	LSP(+)	Output external Loudspeaker Positive
2	HEAD-0 (+)	Output Headset-Speaker Positive
3	GND (HEAD-0)	Output Headset-Speaker Negative
4	EXT-NF	Input external Audio-Signal
5	MIC R DYN	Input Microphone Right Dynamic
6	MIC L GND	Input Microphone Left Ground
7	INTERCOM SWITCH	Intercom Activation Switch (connect to ground for Intercom activation)
8	MIC L DYN	Input Microphone Left Dynamic
9	DATA-RX	RS232 Receive (for Remote Control)

10	do not connect	Pin 10 is used by adapters for device identification
11	+14 / +28V-PWR	Input Power Supply +12V
12	+14 / +28V-PWR	Input Power Supply +12V
13	BATT (-)	Ground Side of Power Supply
14	MIC R GND	Input Microphone Right Ground
15	PTT-0	Push-to-Talk 0 (connect to ground for transmitting)
16	LSP(-)	Output external Loudspeaker Negative (Not identical to ground!)
17	PTT-1	Push-to-Talk 1 (connect to ground for transmitting)
18	MIC R STD	Input Microphone Right (Headset 1)
19	MIC L STD	Input Microphone Left (Headset 0)
20	HEAD 1 (+)	Output 1 Headset-Speaker Positive
21	GND (HEAD 1)	Output 1 Headset-Speaker Negative
22	DATA-TX	RS232 TX (for Remote Control)
23	N/A	do not connect
24	+5VDC OUT	5VDC Power Supply for Remote Control
25	BATT (-)	Ground Side of Power Supply

### 4.7.3 Wiring with Cable Harness BSKS833x-S

#### 4.7.3.1 Overview / Variants of cable sets

Five different cable sets are available for a wide range of applications

BSKS833S-S	Basic cable-set for single-seater
BSKS833D-S	Basic cable-set for double-seater
BSKS833OE-S	Cable-set for double seats (powered aircraft) with open ends
BSKS833GLS-S	Cable-set for single-seater (glider) with open ends
BSKS833GLD-S	Cable-set for double-seater (glider) with open ends

You will find a detailed description of the cable variants, such as the corresponding cable diagram, in document Doc. No. 01.14x.050.50 on our homepage under

[www.funkeavionics.de](http://www.funkeavionics.de) Service / info download / radios

#### 4.7.3.2 Connector D-SUB DE-9 Female for Remote Control

This connector contains the serial interface and the power supplies for the remote control unit.

Connector for the Remote Control in the cable harness BSKS833D-S  View from aircraft's side		1: not connectd 2: Data TX 3: Data RX 5: GND shielding 8: +5VDC
---	---	---

The remote control interface is a serial RX-TX interface with RS232 voltage levels with 9600 baud, 8 data bits, no parity, 1 stop bit, no handshake.

Each message begins with 2 byte sequences 0x02 (STX) and 0x72 ('r') for synchronization followed by a message identification-byte and a different number of data bytes.

Byte #	Value	Description
1	0x02 (STX)	Synchronization
2	0x72 ('r')	Synchronization
3	<i>id</i>	<i>id</i> of message
4...3+n	<i>n data bytes</i>	depending on message
4+n	<i>checksum</i>	XOR of bytes #2 ... #3+n i.e. excluding the STX and the checksum itself

### Byte stuffing

If the STX byte (0x02) appears in the data byte of a message, this byte is doubled to distinguish it from STX. The checksum then contains both 0x02 values.

The standby frequency is set with the ID 0x12 and contains two data bytes:

Data Byte #	Description	Possible Values / Remarks
1	MHz	118...136
2	kHz / 5	0...198 (corresponds to 0...990 kHz)

The standby frequency and the active frequency can also be adjusted by Garmin devices. The protocol corresponds to the Garmin SL40.

### 4.7.3.3 Connector EXT-NF for Monaural Audio Input

This connector is used for the input of monaural audio signals. He can be used e.g. for acoustic traffic warnings, for radio navigation receiver's acoustic identifiers, or for input of music into the headsets.

The priority of radio reception in relation to this input can be configured as described in chapter 3.5.

## 4.8 Antenna

### 4.8.1 Antenna Selection

- A VHF-COM-Antenna with an impedance of 50 Ohm is required.
- Choose an antenna type approved for the aircraft and the mounting location.
- The antenna should be located far away from ELT-antennas and other VHF antennas.
- Specified features depend on proper installation of the antenna.

### 4.8.2 Installation Recommendation

- Take note of the antenna manufacturer's instructions.
- The metallic contact between airplane surface and antenna-GND must be very good. On non-metallic airplanes a metal foil (min. 80 cm x 80 cm) shall be used as electrical counterweight on the inside of the belly.
- To avoid a mutual interference of the radios, the antenna isolation between a voice transmission and a navigation antenna as well as between double COM antennas should be as large as possible. A distance of 2 meters usually is sufficient.
- Assemble the antenna in vertical position so on or under the belly that it is as far distant as possible from all protruding parts (propeller, chassis, vertical stabilizer)
- For glider installation the internal antenna installed by the manufacturer should be used.
- The SWR shall not exceed 3:1.



The HF antenna wire must not be included in any other cable sets, for example power supply or microphone. It must also not be placed together with other antenna wires, for example NAV or Transponder.

## 4.9 Microphone / Intercom settings

The settings of MIC and VOX values are essential for Intercom. The respective configuration options are described in chapter 0 (VOX=threshold level) and chapter 3.6 (MIC input sensitivity).

If the VOX automatism is deactivated with VOX=01 intercom is activated using the intercom switch (not PTT), which connects PIN 7 (intercom) of the equipment connector to GND.

For operation with VOX activated PIN 7 has to be connected to GND permanently.

Transmission merely operates when PTT is pressed.

The suppression of background noise is only possible using differential microphones, as they are usual with modern headsets. Normal electret microphones are not suitable.

## 4.10 Post-Installation Check



A certified maintenance shop must verify proper operation of the VHF Transceiver System.

When installation is completed all steering and control functions of the aircraft are to be examined, in order to exclude disturbances by the wiring.

The SWR shall not exceed 3:1.

Furthermore a test flight is recommended, in order to guarantee the proper in-flight operation of the radio:

- In a flight altitude of at least 2000 ft contact a ground station in a distance of at least 50 km (30 nautical miles).
- Pay attention to unusual electrical interference.
- If possible, perform the radio test on frequencies within the upper and lower VHF communication frequency range

## 4.11 Drawings

### 4.11.1 Dimensions

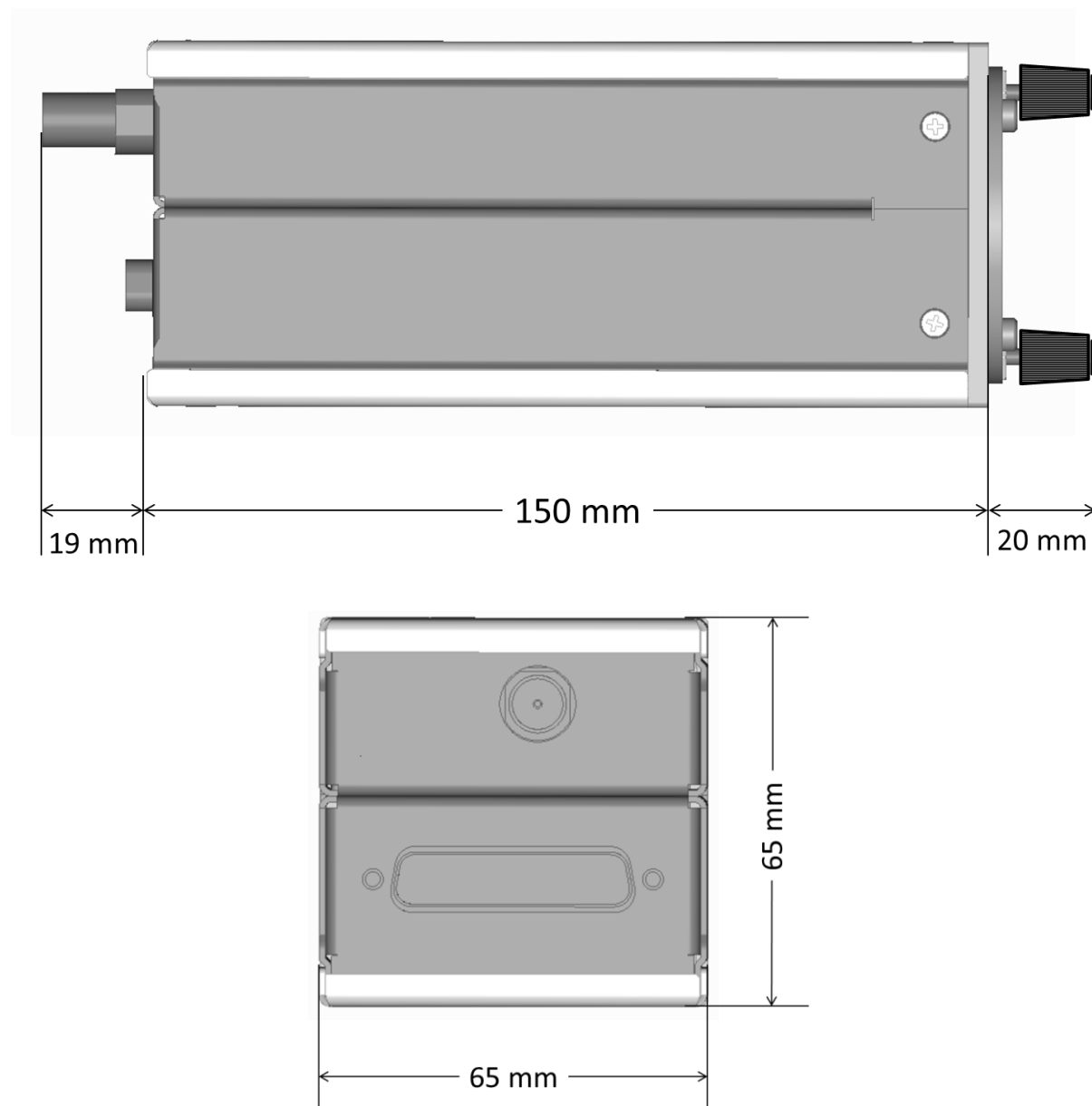



### 4.11.2 Mounting Advices

For mounting in panel with a thickness of 3-5 mm longer screws are available (Order-No. ZUB5).

#### Dimensions in connector area

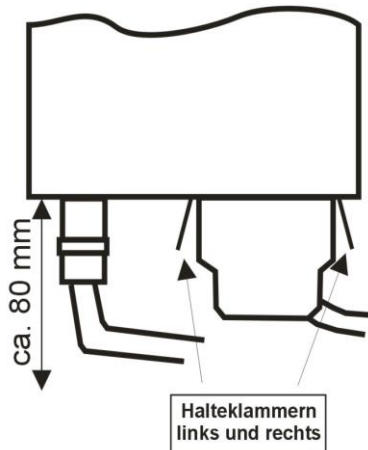

#### Dimensions of panel cut-out

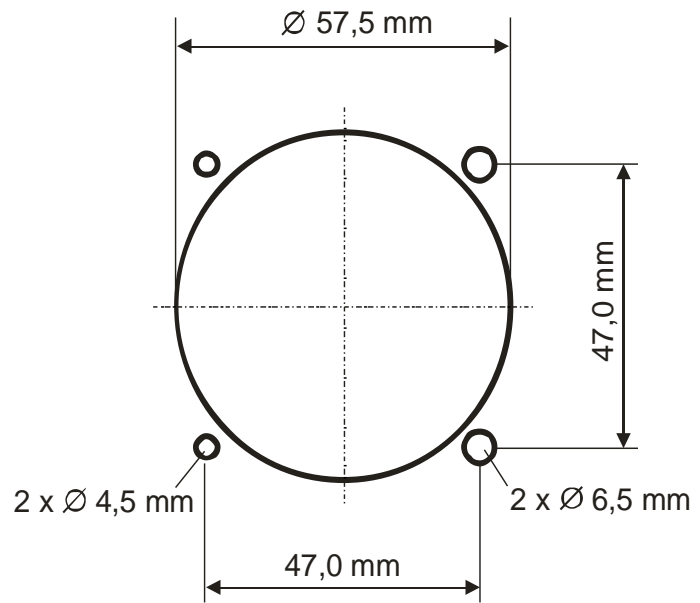

	<p>No screws may be turned in more than max. 15mm into the device – even if no hard limit is noticeable!</p>
	<p>The D-Sub-Connector (plug) has to be clamped with both spring locks. It is recommended to additionally secure them with a cable tie.</p>

## 5 APPENDIX

### 5.1 Frequency/Channel-Plan

In the following table examples for operating and displayed frequencies in the range between 118.000 ... 118.100 MHz are given. This table can be continued to 136.975 MHz following the same scheme.

<b>Operating Frequency (MHz)</b>	<b>Channel Width (kHz)</b>	<b>Displayed Frequency in 8.33/25 kHz Mode</b>	<b>Displayed Frequency in 25 kHz Mode</b>
118.0000	25	118.000	118.000
118.0000	8.33		118.005
118.0083	8.33		118.010
118.0166	8.33		118.015
118.0250	25	118.025	118.025
118.0250	8.33		118.030
118.0333	8.33		118.035
118.0416	8.33		118.040
118.0500	25	118.050	118.050
118.0500	8.33		118.055
118.0583	8.33		118.060
118.0666	8.33		118.065
118.0750	25	118.075	118.075
118.0750	8.33		118.080
118.0833	8.33		118.085
118.0916	8.33		118.090
118.1000	25	118.100	118.100
118.1000	8.33		118.105
etc.	etc.		etc.

## 5.2 Technical Data

GENERAL	
COMPLIANCE	ETSO-2C169a Transceiver Class 4, 6 Receiver Class C, E, H1 & H2 ETSO 2C128
DIMENSIONS	Height: 65 mm (2,56 in) Width: 65 mm (2,56 in) Depth: 169 mm (6,42 in)
WEIGHT	0,46 kg (1,01 lbs)
MOUNTING	Panel Mounted
TEMPERATURE RANGES OPERATION STORAGE	-20 °C ... +55 °C, 30 min at +70 °C -55 °C .. +85 °C
MAX. HEIGHT	35.000ft
VIBRATION	DO-160F, Cat. S, Vibration Curve M
HUMIDITY	RTCA DO-160F, Cat. A
SHOCK	6 G operational 20 G crash
RTCA DO-160F ENV.CAT.	[C1Z] CAB [SM] XXXXXXZ [B(XX)] AB [AC] [TT] M [XXXXX] XXAC
POWER SUPPLY	11.0 – 30.0 VDC nominal 9.0 VDC Emergency operation Transmitter: 2,5A Receiver: 0,2A (Standby), max. 0,5A Audio power amplifier: up to 1A below nominal voltage < 11 VDC ➔ reduced transmitting power
POWER CONSUMPTION	Standby: 2,8W, Transmit 35W
FUSE	external fuse required: 4 A, slow-blow
FREQUENCY RANGE	118,000 MHz .. 136,975 MHz
FREQUENCY STABILITY	±5 ppm bei -20 °C .. + 55 °C
COMPASS-SAFE DISTANCE	30 cm
INTERCOM-INPUT	Microphone inputs are connected to the intercom input. 100 mV <sub>RMS</sub> at the microphone

	input produce 0,5W output power at the headphone (300Ω).
NF (AUDIO) - INPUT	1V / 600Ω
<b>TRANSMITTER</b>	
POWER OUTPUT	6 W (nominal) 4 W (minimum)
HARMONIC DISTORTION	< 10 % at 70 % Modulation
SIDETONE OUTPUT	>0,5W at 300Ω (headphone output)
MICROPHONE INPUTS	2 Inputs for Standard or dynamic microphones with automatic detection of the microphone type Standard: 50mV - 2V at 100Ω Dynamic: 5mV <sub>pp</sub> – 10mV <sub>pp</sub>
HARMONIC CONTENT	>60dBc
MODULATION FIDELITY	Deviation <6dB von 350-2500kHz
CARRIER NOISE LEVEL	>35dB at 70% modulation
UNWANTED FREQUENCY-MODULATION	<1kHz at m=70% / 1kHz
DUTY CYCLE	capable of continuous transmission, automatic interrupt after 35 seconds
<b>RECEIVER</b>	
SENSITIVITY	-105 dBm (>6 dB S+N/N, m = 30 % /1 kHz)
BANDWIDTH / 25 kHz	-6-dB-bandwidth > ±8.0 kHz
BANDWIDTH / 8.33 kHz	-6-dB-bandwidth > ±2.78 kHz
SELECTIVITY (channel spacing 25 kHz)	-40-dB-bandwidth < ±17.0 kHz -60-dB-bandwidth < ±25.0 kHz
SELECTIVITY (channel spacing 8.33 kHz)	-60-dB-bandwidth < ±7.37 kHz
NF-OUTPUT	≥4 W at 4 Ω (speaker output)
AGC CHARACTERISTICS	AF output deviation < 6 dB from 10 μV to 10 mV
SQUELCH	automatic Squelch (adjustable)
SPURIOUS RESPONSES	> 80 dB
DISTORTION (350...2500Hz)	<25% at rated power (85% / -33dBm) / <10% at 10dB below rated power (70% / -33dBm)

### 5.3 Environmental Conditions

CHARACTERISTICS DO-160F	SECTION	CAT	CONDITION
TEMPERATURE / ALTITUDE	4.0		
LOW GROUND SURVIVAL TEMPERATURE	4.5.1	C1	- 55°C
LOW OPERATING TEMPERATURE	4.5.1		- 20°C
HIGH GROUND SURVIVAL TEMPERATURE	4.5.2		+ 85°C
HIGH SHORT-TIME OPERATING TEMPERATURE	4.5.2		+ 70°C
HIGH OPERATING TEMPERATURE	4.5.3		+ 55°C
IN-FLIGHT LOSS OF COOLING	4.5.4	Z	No auxiliary cooling required
ALTITUDE	4.6.1	C1	35 000 ft
TEMPERATURE VARIATION	5.0	C	2°C change rate minimum per minute
HUMIDITY	6.0	A	
SHOCK	7.0	B	6 G operational shocks (11ms) 20 G Crash Safety Test Type R in all 6 directions (11ms)
VIBRATION	8.0	S	Vibration Curve M
EXPLOSION PROOFNESS	9.0	X	No test required
WATER PROOFNESS	10.0	X	No test required
FLUIDS SUSCEPTIBILITIES	11.0	X	No test required
SAND AND DUST	12.0	X	No test required
FUNGUS RESISTANCE	13.0	X	No test required
SALT SPRAY	14.0	X	No test required
MAGNETIC EFFECT	15.0	Z	< 0,3 m Compass Safe Distance
POWER INPUT (DC)	16.0	B	
VOLTAGE SPIKE CONDUCTED	17.0	A	
AUDIO FREQUENCY CONDUCTED SUSCEPTIBILITY	18.0	B	

CHARACTERISTICS DO-160F	SECTION	CAT	CONDITION
INDUCED SIGNAL SUSCEPTIBILITY	19.0	AC	
RADIO FREQUENCY SUSCEPTIBILITY	20.0	T	
EMISSION OF RF ENERGY	21.0	M	
LIGHTNING INDUCED TRANSIENT SUSCEPTIBILITY	22.0	X..	No ED23 test, not required
LIGHTNING DIRECT EFFECTS	23.0	X	No test required
ICING	24.0	X	No test required
ELECTROSTATIC DISCHARGE (ESD)	25.0	A	
FIRE, FLAMMABILITY	26.0	C	

Notes:



# f.u.n.k.e.

AVIONICS GMBH

## **f.u.n.k.e. AVIONICS GmbH**

Heinz-Strachowitz-Str. 4  
DE-86807 Buchloe  
Germany

phone.: +49-8241 80066 0

fax.: +49-8241 80066 99

E-mail:

[service@funkeavionics.de](mailto:service@funkeavionics.de)

[www.funkeavionics.de](http://www.funkeavionics.de)