

ATR833S

VHF Communication Transceiver



P/N 833S-(Cxxx)-(Cxxx)

Operation and Installation

(Document-Nr. 01.142.010.71e)

Change History

Revision	Date	Change Description
1.00	27.01.2017	First release for 2-DS / 2x8 LCD HMI Firmware Rev1.0 Head Software Rev1.0
1.01	14.02.2017	Chap. 2.4.6 Note on ATR frequency tool inserted / chap. 4.7.3.2 Note Garmin protocol inserted / chap. 5.2 corrected / general correction
1.02	29.03.2017	New P/N inserted for device variants Firmware Rev1.01; Head Software Rev1.01
1.03	24.05.2017	Description of device variants removed
1.04	03.08.2017	Chapter 4.7.3. Cable plan BSKS833D-S removed - New document of the cable sets referenced
1.05	13.09.2017	Chapter 2.4.2 and 4.7.2 corrected
1.06	13.02.2018	Update for NF-Fw 3.00, Chap. 3.8 and 3.12 amended, Correction in Chap. 4.7.3.2
1.07	25.04.2018	Chap. 4.7.2 Pin assignment adapted to modified Hw, Chap. 3.6 and 4.6.1 newly described

List of Service-Bulletins (SB)

Service-Bulletins are to be inserted in the manual and to be recorded in this table

SB Number	Rev. No.	Date of Issue	Entry Date	Name

Content

1	GENERAL	5
1.1	SYMBOLS	5
1.2	ABBREVIATIONS.....	5
1.3	CUSTOMER SERVICE	6
1.4	FEATURES.....	6
2	OPERATION	7
2.1	OVERVIEW OF CONTROLS	7
2.2	ON/OFF – COMMISSIONING.....	8
2.3	DISPLAY	9
2.4	FREQUENCY SETTING	11
2.4.1	<i>Automatic Selection 8.33 / 25kHz Channel Bandwidth</i>	11
2.4.2	<i>Manual Frequency Input</i>	12
2.4.3	<i>Recall a Frequency from the User Memory</i>	13
2.4.4	<i>Recall a Frequency from the List of the 10 Last Used</i>	14
2.4.5	<i>Editing of the user-defined frequency list</i>	14
2.4.6	<i>ATR Frequency-Tool</i>	16
2.5	BASIC SETTINGS.....	16
2.5.1	<i>VOL – Volume</i>	17
2.5.2	<i>SQL – Squelch (noise barrier)</i>	17
2.5.3	<i>VOX – Voice Activated Intercom</i>	18
2.5.4	<i>INT – Intercom Volume</i>	19
2.5.5	<i>STL – Volume Sidetone Left</i>	19
2.5.6	<i>STR – Volume Sidetone Right</i>	20
2.5.7	<i>EXT – Volume of the external Audio Input</i>	20
2.5.8	<i>BRT – Brightness</i>	21
2.5.9	<i>CON – Contrast</i>	21
2.6	TRANSMISSION.....	21
2.7	RECEPTION	22
2.8	DUAL WATCH MODUS.....	23
3	CONFIGURATION	25
3.1	CHANNEL SPACING	26
3.2	DISPLAY – ENERGY SAVING MODE (AUTOMATIC DISPLAY DARKENING).....	27
3.3	PTT SLCT – PTT BUTTON SELECTION	28
3.4	DUOWATCH – DUAL-WATCH VOLUME REDUCTION	29
3.5	EXTAUDIO – BEHAVIOUR OF EXTERNAL AUDIO INPUT	30
3.6	MIC – SELECTION MICROPHONE TYPE.....	31
3.7	MIC L/R – MICROPHONE INPUT SENSITIVITY.....	32
3.8	HEAD OUT – HEADSET CONFIGURATION	33
3.9	AUTO ON – POWER-ON BEHAVIOUR.....	34
3.10	FW / SW – FIRMWARE / SOFTWARE VERSION.....	34
3.11	MASTER RESET - RESET TO FACTORY SETTINGS	35
3.12	ADAPTER OPERATION	36
3.13	OVERVIEW CONFIGURATION MENU (SETUP).....	37
4	INSTALLATION	38
4.1	ADVICE AND TIPS	38
4.2	TELECOMMUNICATION DATA	38
4.3	SCOPE OF DELIVERY.....	38
4.4	UNPACKING AND INSPECTION OF THE EQUIPMENT.....	39
4.5	MOUNTING	39

Operation and Installation



4.6	EQUIPMENT CONNECTIONS	40
4.6.1	<i>Microphone Connection</i>	40
4.6.2	<i>Headset-Connection</i>	40
4.6.3	<i>Audio-Input</i>	40
4.6.4	<i>Operation with Cable Adapter</i>	41
4.7	WIRING	41
4.7.1	<i>Cable Cross Section</i>	41
4.7.2	<i>Connector – Pin Allocation</i>	41
4.7.3	<i>Wiring with Cable Harness BSKS833x-S</i>	43
4.8	ANTENNA.....	45
4.8.1	<i>Antenna Selection</i>	45
4.8.2	<i>Installation Recommendation</i>	45
4.9	MICROPHONE / INTERCOM SETTINGS.....	46
4.10	POST-INSTALLATION CHECK	46
4.11	DRAWINGS	47
4.11.1	<i>Dimensions</i>	47
4.11.2	<i>Mounting Advice</i>	48
5	APPENDIX	49
5.1	FREQUENCY/CHANNEL-PLAN	49
5.2	TECHNICAL DATA	50
5.3	ENVIRONMENTAL CONDITIONS.....	51

Operation and Installation

1 GENERAL

This manual contains information about the physical, mechanical and electrical characteristics, as well as information about installation and operation of the aeronautical VHF voice radio ATR833S.

1.1 Symbols

	<p>Advice, non-observance of which could cause radiation damage to the human body or ignition of combustible materials.</p>
	<p>Advice, non-observance of which could cause damage to the device or other parts of the equipment.</p>
	<p>Information</p>

1.2 Abbreviations

Abb.	Name / Subject	Definition
BRT	Brightness	Display Brightness
EXT	External Audio Input	Volume of external audio input
INT	Intercom	Volume of board-internal intercom
MIC	Microphone	Sensitivity of Microphone
PTT	Push-To-Talk	Button to activate radio transmission
SEL	Selection	Selection of value or function
SQ	Squelch	Noise suppression radio reception
VOL	Volume	Volume of radio reception
VOX	Voice activation	Volume threshold for voice-activated

Operation and Installation

1.3 Customer Service

In order to facilitate a rapid return of shipments in case of repairs, please follow the instructions of the input guide “Reshipment RMA” provided at the Service-Area within the f.u.n.k.e. AVIONICS GmbH web portal www.funkeavionics.com.

	<p>Any suggestions for improvement of our manuals are welcome. Contact: service@funkeavionics.com.</p>
---	---

	<p>Information on software updates is available at f.u.n.k.e. AVIONICS GmbH.</p>
---	--

1.4 Features

- VHF communication transceiver with 6W output power in 2 ¼” format
- Frequency range 118,000 to 136,975 MHz
- 2 microphone inputs (auto detection standard or dynamic)
- Voice controlled intercom for up to 4 microphones, can be deactivated for use with an external intercom
- Dual-watch technology, simultaneous monitoring of two frequencies
- Auxiliary audio input
- Memory for 20 user-definable named frequencies
- Easy recall of the 10 last used frequencies
- High contrast 64x128 dot matrix LCD display
- Wide range power supply 11 – 30 VDC
- Configurable energy saving mode

	<p>To avoid unintentional permanent transmission, the transmitter automatically stops transmission after 35 seconds of uninterrupted operation.</p>
---	---

Operation and Installation

2 OPERATION

2.1 Overview of Controls



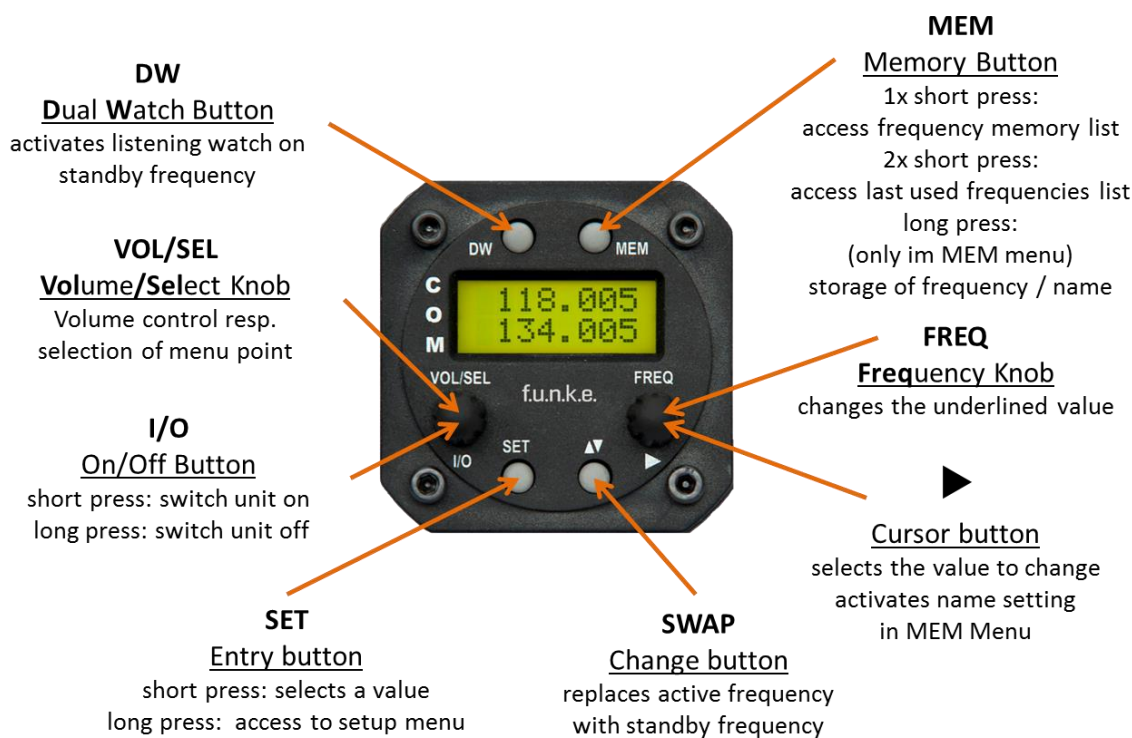

Position and naming of control elements:



The control elements have following functionality:

I/O	ON/OFF	Switch On press button for appr. 0,5 s Switch Off press button for appr. 2 s
DW	DUAL WATCH	Activates/deactivates the mode for mutual reception of standby frequency (display shows DW instead of SBY)
SET	SET	1. Navigation through the standard menu (VOL, SQL, VOX, etc.) (adjustment of value with VOL/SEL, short press ► for next value 2. Access to setup menu → Press button for min. 5 seconds 3. Navigation through the setup menu (Spacing, backlight, DW Mute, PTT Select.)

Operation and Installation

	CURSOR	<ol style="list-style-type: none"> 1. Marking (underline) of value for adjustment; value changeable with FRQ or VOL/SEL → Enter and continue with Cursor Button  short press 2. Activates the entry of names in MEM menu
	SWAP	Changes active with standby-Frequency
MEM	Memory	Access to frequency list (MEM-List) → press button shortly once
		Access list of 10 last used frequencies (LST-List) → press button shortly twice
		Store active frequency to selected memory (in MEM-List) → press button for 2 seconds
 VOL/SEL	VOL/SEL Turn knob	<ol style="list-style-type: none"> 1. Adjust volume or other item selected by SET (VOL, SQ, VOX, DIM etc.) 2. Select frequency from user memory or list of last used frequencies
 FREQ	FREQ Turn knob	Change the underlined value (i.e. adjust standby frequency, or input character when entering name)

2.2 ON/OFF – Commissioning

Turn the device on/off by pressing the **VOL/SEL** turn knob.

Switch On:  press for appr. 0.5 seconds

Switch Off:  press for appr. 2 seconds

After turning on the following information appears on the display:

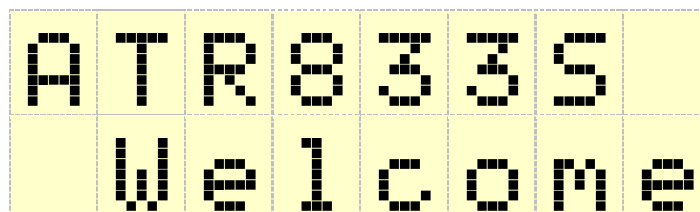

The start screen indicates the device type. After that screen the device changes into normal operation (direct input mode).

Operation and Installation

The radio starts with the same frequencies and settings from before being switched off.

2.3 Display

The ATR833S display shows the frequencies and the operating condition on a 2 line LCD each with 8 digits. The active frequency is shown in the upper line, the stand-by frequency in the lower line.

The tuned frequencies are shown in the 25kHz as well as in the 8.33kHz channel separation mode, with six digits.

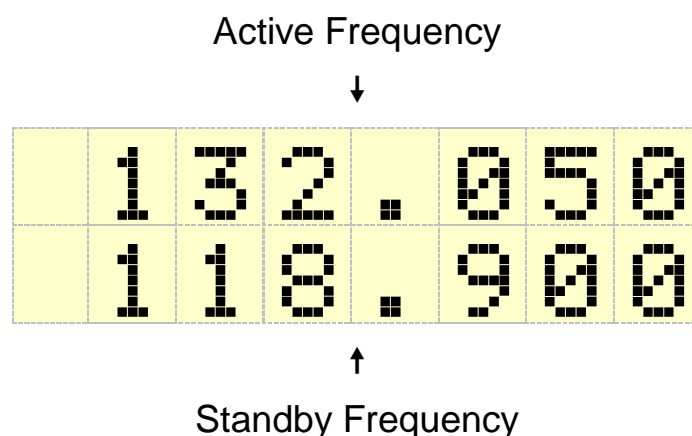

Symbols and letters shown before a frequency have the following meanings:

Display	Meaning	Remark
118.000	First line Active frequency	Frequency used for transmissions and receptions
No symbol	Normal operating condition	Reception on the active frequency
Y	Signal received on the active frequency	Reception of a signal on the active frequency
124.910	Second line Standby frequency	Can be monitored in the Dual Watch Mode
#	Symbol before Standby frequency with activated Dual Watch mode	Dual watch mode allows intermittent monitoring of standby frequency activity
*	Transmitting on active frequency	PTT pressed

Operation and Installation

>	Memory stored	shows the successful storage of a frequency
LOW BATT	Very low supply voltage	Transmission only with reduced power possible (decreased radio range!)
VOL 06	Volume level for receiving	standard display when turning VOL/SEL knob
SQL 03	Squelch level	Radio signal strength threshold required for reception; suppresses noise and weak/distant transmitter
VOX 05	VOX threshold	Speech level that activates the intercom
INT 04	Intercom - Volume	Volume of Intercom
STL 06	Sidetone Left - Volume	Volume Sidetone of left headset
STR 06	Sidetone Right - Volume	Volume Sidetone of right headset
EXT 02	Volume of external audio signals	Set to 00, if no device is connected, to prevent noise pick-up.
BRT 07	Brightness of display	Brightness of backlight LED
CON 05	Contrast of display	
MEM	Item from user defined frequency list	
LST	Item from list of last used frequencies	
ABCDEF	User-provided name for frequency within user memory	Displayed while selecting from user memory, when the user has provided a name for this specific memory entry

2.4 Frequency Setting

Frequency setting is always done by in two steps, as follows:

1. entering a new standby frequency to the desired value, and then
2. interchanging the new standby frequency and the previous active frequency by using the swap button ▼▲.

Entering a new standby frequency can be done by

- a. manual input,
- b. recall of previously stored frequencies from the user memory (memory locations 1-20), or
- c. recall from the list of the last 10 used frequencies.

2.4.1 Automatic Selection 8.33 / 25kHz Channel Bandwidth

Whether a frequency is used with channel width 8.33kHz or 25kHz, is automatically determined by the value of the frequency entered and requires no additional user activity.

The numbering scheme that is used for distinction of the two channel widths is internationally standardized by the ICAO, and consistently used in official documents (e.g. VFR navigation charts) as well as in the voice phraseology used in ATC radio communication.

Channels used with 25kHz width are entered in multiples of 25kHz: 123.500, 123.525, 123.550, 123.575, 123.600 etc. These are compatible with the old 25 kHz-only radios. To use the same frequencies with 8.33 kHz width, the frequency values entered are increased by 5kHz: 123.505, 123.530, 123.555, 123.580, 123.605 etc.

For more detailed information please refer to chapter 5.1 – but, as said above, for correct channel width selection this knowledge is not required.

2.4.2 Manual Frequency Input

The standby frequency is inputted by

- selecting with the ► button which part of the frequency to change, and
- changing the selected part with the **FREQ** rotary knob.

The swap button ▼▲ interchanges the newly set standby frequency and the former active frequency.

	<p>In order to speed up the entering of new frequencies, it is possible to configure the radio to allow entering only those frequencies that are used with 25 kHz channel width.</p> <p>Please refer to chapter 3.1 for information on this configuration.</p> <p>However, when choosing this option, please keep in mind to re-enable 8.33 kHz channel selection before flying into areas where 8.33 kHz channels are used.</p>
--	--

When having the channel selection configured for 8.33 kHz steps (see 3.1), the frequency input is in three steps:

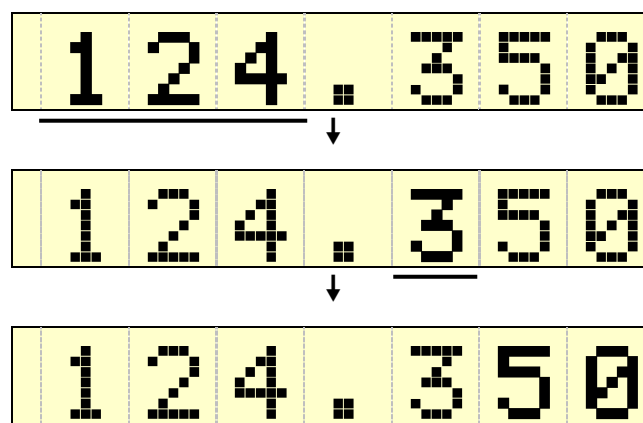

Operation and Installation

2.4.3 Recall a Frequency from the User Memory

To access the user memory frequency list, press **MEM** once, and select one of the 20 memory entries with the **VOL/SEL** turn knob.

The selected memory entry substitutes the former standby frequency.

In the upper line of the display, the number of the memory entry selected is indicated by [MEM xx] (with xx = 00 to 19); if a name has been provided by the user for this memory entry, it is displayed instead of the memory number.

M	E	M	:				2
	1	1	8	.	2	7	5

Respectively

K	O	N	S	T	A	N	Z
	1	2	4	.	3	5	0

A push on the swap button ▼▲ interchanges the newly set standby frequency and the former active frequency and leaves the memory list menu.

If no input is done for 10 seconds the device returns to the standard view.

Operation and Installation

2.4.4 Recall a Frequency from the List of the 10 Last Used

The radio automatically keeps track of the last 10 used active frequencies. To access this list, press **MEM** twice and select one of the 10 entries listed with the **VOL/SEL** turn knob. With a press on the **SET** button the selected memory entry substitutes the former standby frequency. A press on the SWAP button ▼▲ substitutes the active frequency and terminates the memory selection.

↗ Range 1 - 10

L	S	T	:				9
	1	1	8	.	2	7	5

↗ 8 digits A-Z / 0-9

E	D	N	E				
	1	1	8	.	2	7	5



List entry „1“ contains the last standby frequency from the MEM menu

If no input is done for 10 seconds, the device returns to the standard view.

2.4.5 Editing of the user-defined frequency list

The standby frequency can be stored into any entry of the user memory.

This is achieved by a long press of approx. 1,5 seconds on **MEM**. The previous memory entry will be overwritten.

The following example stores the frequency 124.350 MHz of KONSTANZ (EDTZ) into the user memory entry 07:

Operation and Installation

Step	Display (Example)															
<p>1. <u>Tune in frequency:</u> Have frequency to be stored set as standby frequency</p>	<table border="1" style="width: 100%; text-align: center;"> <tr><td>1</td><td>1</td><td>8</td><td>.</td><td>2</td><td>7</td><td>5</td></tr> <tr><td>1</td><td>2</td><td>4</td><td>.</td><td>3</td><td>5</td><td>0</td></tr> </table>	1	1	8	.	2	7	5	1	2	4	.	3	5	0	
1	1	8	.	2	7	5										
1	2	4	.	3	5	0										
<p>2. <u>Enter memory list:</u> Long press on MEM in order to access the user memory.</p>	<table border="1" style="width: 100%; text-align: center;"> <tr><td>s</td><td>a</td><td>v</td><td>e</td><td>T</td><td>o</td><td>1</td></tr> <tr><td>1</td><td>2</td><td>4</td><td>.</td><td>3</td><td>5</td><td>0</td></tr> </table>	s	a	v	e	T	o	1	1	2	4	.	3	5	0	
s	a	v	e	T	o	1										
1	2	4	.	3	5	0										
<p>3. <u>Select memory position:</u> Selection of the decided memory position with VOL/SEL</p>	<table border="1" style="width: 100%; text-align: center;"> <tr><td>s</td><td>a</td><td>v</td><td>e</td><td>T</td><td>o</td><td>7</td></tr> <tr><td>1</td><td>2</td><td>4</td><td>.</td><td>3</td><td>5</td><td>0</td></tr> </table>	s	a	v	e	T	o	7	1	2	4	.	3	5	0	
s	a	v	e	T	o	7										
1	2	4	.	3	5	0										
<p>4. <u>Overwrite the selected memory :</u> with a press of MEM the standby frequency is stored at the selected position. A preceding > shows the successful storage to the memory position.</p>	<table border="1" style="width: 100%; text-align: center;"> <tr><td>M</td><td>E</td><td>M</td><td>:</td><td></td><td></td><td>7</td></tr> <tr><td>></td><td>1</td><td>2</td><td>4</td><td>.</td><td>3</td><td>5</td><td>0</td></tr> </table>	M	E	M	:			7	>	1	2	4	.	3	5	0
M	E	M	:			7										
>	1	2	4	.	3	5	0									

To exit the frequency list press **MEM** twice or wait 10 seconds until time-out.

Every memory position can also store an identifier with up to 8 digits next to the frequency.

<p>To add a name go to the selected memory entry. To add the name, follow the next steps as for step 3 or step 4, above</p> <p>5. <u>Change to name entry:</u> a long press of the Cursor button ► enables the entry of a name</p>	<table border="1" style="width: 100%; text-align: center;"> <tr><td>A</td><td></td><td></td><td></td><td></td><td></td><td></td></tr> <tr><td>1</td><td>2</td><td>4</td><td>.</td><td>3</td><td>5</td><td>0</td></tr> </table>	A							1	2	4	.	3	5	0	
A																
1	2	4	.	3	5	0										
<p>6. <u>Enter the name:</u> By changing the selected character with FREQ, and advancing the selection with ►, in the same way as manually entering a standby frequency.</p>	<table border="1" style="width: 100%; text-align: center;"> <tr><td>K</td><td>O</td><td>N</td><td>S</td><td>T</td><td>A</td><td>N</td><td>Z</td></tr> <tr><td>1</td><td>2</td><td>4</td><td>.</td><td>3</td><td>5</td><td>0</td></tr> </table>	K	O	N	S	T	A	N	Z	1	2	4	.	3	5	0
K	O	N	S	T	A	N	Z									
1	2	4	.	3	5	0										

Operation and Installation

7. Store the name:

The new entry is stored with the entry of the last digit. The name is now shown in the frequency list.

K	O	N	S	T	A	N	Z
	1	2	4	.	3	5	0

To exit the frequency list press **MEM** twice or wait 10 seconds until time-out.

2.4.6 ATR Frequency-Tool

The ATR Frequency Tool supports the ATR833S from version 1.3. With the tool you can manage the frequency memory of the ATR833S, i.e. frequencies can be added, edited and deleted. The frequency list can be stored as a file.

The ATR Frequency Tool can be downloaded from the f.u.n.k.e. AVIONICS homepage in the Service Area under Info / Download.

2.5 Basic Settings

To choose between the following settings, use the **SET** button:

1. VOL Volume (chosen by default)
2. SQL Squelch (noise suppression)
3. VOX Voice Activated Intercom
(speech level required to activate the intercom)
4. INT Volume Intercom
5. STL Volume Sidetone left
6. STR Volume Sidetone right
7. EXT Volume of external audio signals
8. BRT Display brightness
9. CON Display contrast
- ... back to Volume

The return to the default display (VOL) is carried out by a long press of SET or happens automatically after 10 seconds of inactivity.

The chosen setting can be adjusted by the **VOL/SEL** rotary knob.

Operation and Installation

2.5.1 VOL – Volume

The radio returns automatically to the volume setting, when a value has been set with the VOL/SEL turn knob.

Turning the **VOL/SEL** knob adjusts the volume of received radio signals. The higher the value, the louder the reception of radio signals.

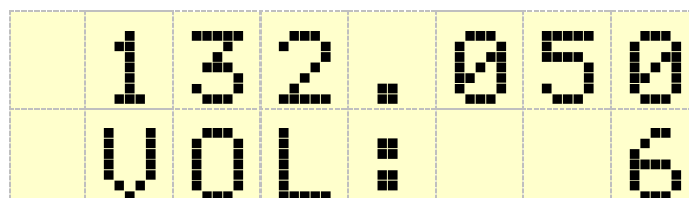

↪ Range 1 – 20



The VOL setting controls the volume of received radio signals only, not the volume of the intercom or the external audio input – these are set separately with INT and EXT.

2.5.2 SQL – Squelch (noise barrier)

In the Squelch Menu SQL the squelch level can be adjusted with the help of the **VOL/SEL** rotary knob. (Note: This is not related in any way to the intercom functionality.)

This is a threshold that has to be exceeded by radio signal levels from other transmitters in order to activate the reception circuitry. The higher the number, the stronger the radio signals have to be in order to be received.

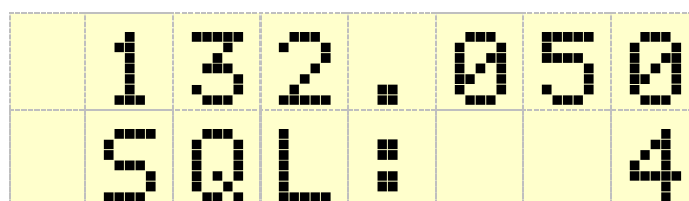

↪ Range 0 - 9

The setting for the squelch depends on different factors. For motor aircraft an initial higher setting is typically appropriate, gliders may use a lower value. A lower number means higher input sensitivity. This allows reception of weaker signals (radio stations at greater distance), but can

Operation and Installation

also result in pickup of own-aircraft radio interference sources (engine, strobe lights etc.).



The default squelch setting is 05. At higher values weak signals will be suppressed.

2.5.3 VOX – Voice Activated Intercom

By briefly pressing the **SET** key twice, and then using the rotary knob, the threshold volume **VOX** for intercom voice detection can be adjusted. (Note: This is not related in any way to radio reception or squelch.)

VOX defines the crew's speech volume that is required to activate the intercom functionality. The higher the value, the louder you need to speak in order to activate the intercom.

Exception: VOX 0 corresponds to "always on"

The internal filter circuitry has the ability to distinguish between engine noise and speech.

	1	3	2	.	0	5	0
	V	O	X	:			4

↪ Range 0 – 9

In the case of very noisy backgrounds, or use of uncompensated microphones, the automatic VOX functionality may not work adequately.

In these cases, it is possible to deactivate the VOX automatics with VOX: 0 = off, and to use an external intercom-switch instead.

Operation and Installation

2.5.4 INT – Intercom Volume

By pressing the SET button three times, the volume of the intercom can be adjusted with the VOL/SEL turn knob.

The intercom function is the on-board crew-internal communication for multi-seater aircraft.

A change in the intercom volume level also changes the volume of the sidetone. The sidetone is an audible feedback of one's own voice to the headset, i.e. you hear yourself speak. This feature supports natural speech behaviour.

The intercom can be activated in two ways:

- Automatically, i.e. whenever someone speaks into a microphone (i.e. voice activated intercom = VOX, see § 0).
- Manually, i.e. by use of an external intercom switch.

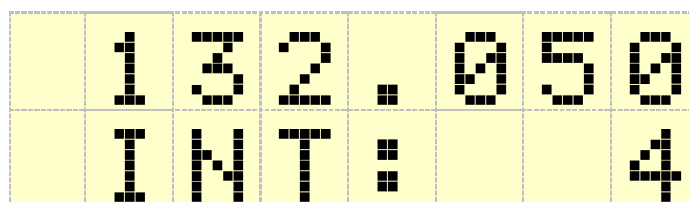

↪ Range 0 - 20



If the intercom is deactivated by the wiring set-up, the intercom volume cannot be adjusted.

2.5.5 STL – Volume Sidetone Left

The sidetone is a self-hearing or back-hearing function during transmission and intercom. The audio signal picked up by the microphone is fed directly to the headset, which sounds natural. In this menu the volume of the sidetone for the left seat can be adjusted.

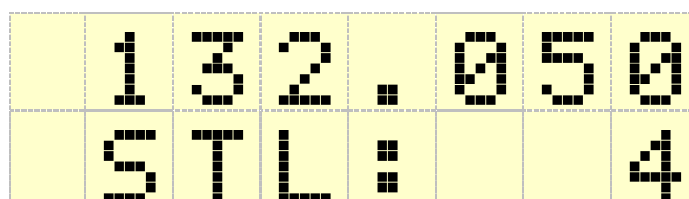

↪ Range 0 – 20

Operation and Installation

2.5.6 STR – Volume Sidetone Right

By briefly pressing the **SET** button five times you get access to the STR menu. Here the volume of the sidetone for the right seat can be adjusted.

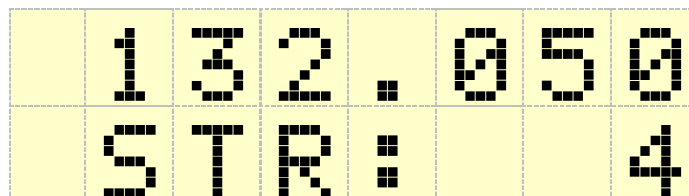

↪ Range 0 – 20

2.5.7 EXT – Volume of the external Audio Input

By briefly pressing the **SET** key six times, and then using the rotary knob, the volume from the connected external audio signals (Warning tones, music, etc. ...) can be set.

The higher the value, the higher will be the volume of the external audio signal. A value of **EXT** = off deactivates the external audio input.

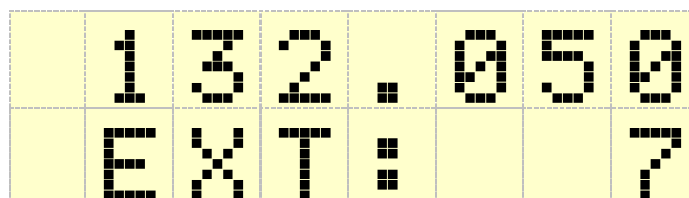

↪ Range off - 20



When no other device is connected to the external audio input, the input should be muted by selecting “off” in order to prevent noise by pickup of on-board interferences.



The priority of the external audio input, in comparison to radio reception, can be configured, see chapter 3.5.

Operation and Installation

2.5.8 BRT – Brightness

By pressing the **SET** seven times the brightness of the backlight of the LCD display can be switched on and off (or adjusted) with the VOL/SEL turn knob.

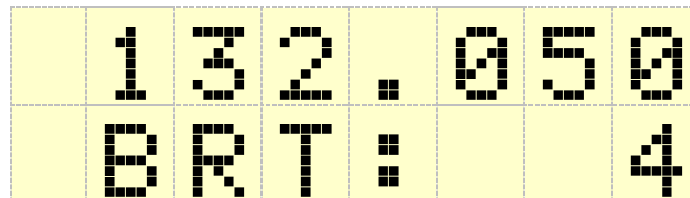

↪ Range 0 – 9

2.5.9 CON – Contrast

By pressing the **SET** eight times the last configuration item is reached in the standard menu, where the contrast of the display can be adjusted with the **VOL/SEL** turn knob.

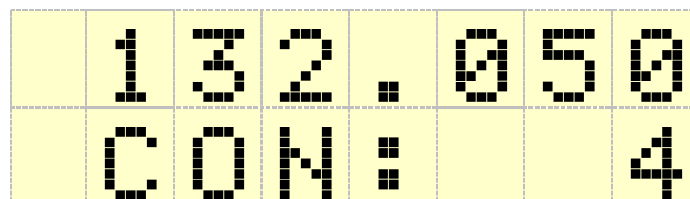

↪ Range 0 – 9

2.6 Transmission

By pushing the PTT button, the device starts transmission on the active frequency. The operation of the transmission is indicated by “*” in front of the frequency used.

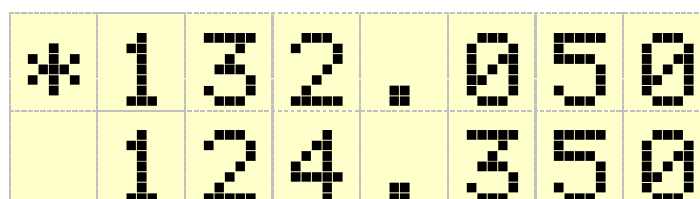

Operation and Installation

In order to avoid unintended transmissions, e.g. when having the PTT button stuck (“stuck mic”), the transmitter automatically stops after 35 ±5 seconds of transmission.

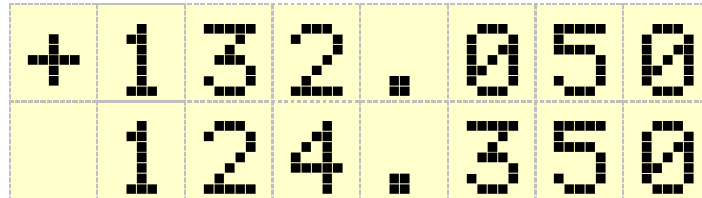

In order to re-enable transmission in this case, release PTT and push it again.

	When having more than one PTT button and microphones connected, the system can be configured (chapter 3.3) to use only one PTT button for transmissions.
---	--

2.7 Reception

When receiving, an antenna symbol “Y” is shown in front of the active frequency.

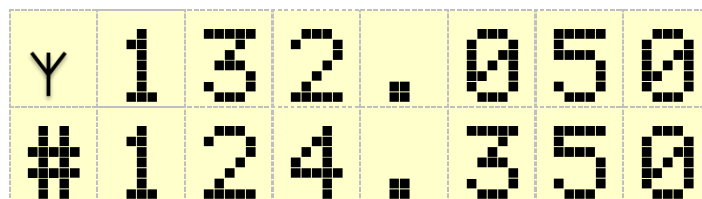

When having dual watch active (see 3.4) this can be shown for the standby frequency, too.

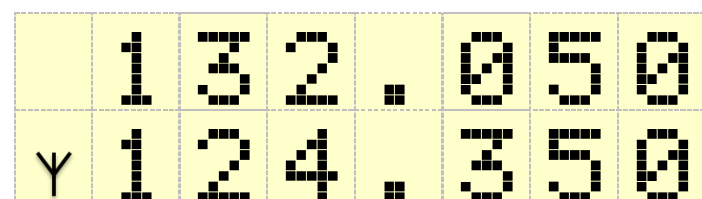

2.8 Dual Watch Modus

The ATR833S comprises one receiver; therefore DUAL-Watch (simultaneously monitoring two frequencies) is implemented by alternating automatically between the active and the standby frequency.

With dual watch mode active, the standby frequency is tuned in, very briefly interrupted in regular intervals by the set auto-tuning to the active frequency for a fraction of a second.

Every radio signal then detected on the active frequency has priority, and pauses the dual watch monitoring of the standby frequency, as long as the reception/transmission continues on the active frequency.

Transmissions are always done on the active frequency.

The dual watch mode is activated by pressing **DW**, and is indicated by a # symbol in front of the standby frequency.

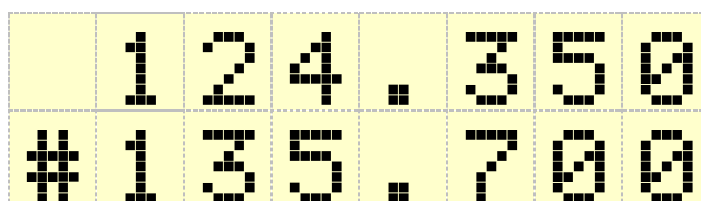

The dual watch mode is deactivated by pressing **DW** again, and by any operations changing either of the frequencies.



SQL has to be set to 01 at least, as without adequate squelch functionality the radio is not able to detect if there is a reception on the active frequency.

In order to have an audible distinction between receptions on the active and the standby frequency, it is possible to hear the receptions from the standby frequency with a lower volume. Please refer to chapter 3.4. for information about the feature “dual watch volume reduction”.

Operation and Installation

Quick approach:

- Select or enter a standby frequency which is to be additionally monitored.
- Set **SQL** with the **SET** button and the rotary knob to a value of at least 01.
- Activate dual watch with **DW** (**DW** is shown)
- As soon as no reception is determined on the active frequency, the mutual monitoring between active and standby frequency starts.
- In order to deactivate dual watch: press **DW** once more or change the frequency.



Don't forget to interchange the active and standby frequencies, before answering a call on the standby frequency.

3 CONFIGURATION

A very long press of **SET** (5 seconds) gives access to the configuration menu (Setup). The configuration menu is used for fundamental settings.

To choose between the following settings, use the **SET** button:

1. SPACING Channel spacing
2. DISPLAY Display darkening (power save mode)
3. PTT SLCT PTT button selection
4. DUOWATCH Dual Watch muting
5. EXTAUDIO Behaviour of the external audio input
6. MICL TYP Microphone type left
7. MIC L STD Microphone sensitivity left (standard mic)
8. MIC L DYN Microphone sensitivity left (dynamic mic)
9. MIC R TYP Microphone type right
10. MIC R STD Microphone sensitivity right (standard mic)
11. MIC R DYN Microphone sensitivity right (dynamic mic)
12. HEAD OUT Headset configuration
13. AUTO ON Automatic power on with cockpit power
14. FW Firmware version
15. SW Software version

In the configuration menu the first line shows the menu name and the adjustment value is shown in the second line.

As with the basic settings, a return to the standard display from each menu point is carried out automatically 10 seconds after the last input (time-out), by frequency input or by a long press of the **SET** button.

At the end of all menu items, you return to the default display.

The selection of the values is done with the **VOL/SEL** turn knob.

3.1 CHANNEL SPACING

With this setting, the ATR833S can be configured to limit frequency selection to 25 kHz channels only. This can be used to speed up the manual frequency input in areas where no 8.33 kHz channel spacing is used.

See chapter 0 for further information on manual frequency input.

Using the **VOL/SEL** turn knob the following options can be selected in this submenu:

8.33 kHz: allows input of both 8.33 kHz and 25 kHz channels

S	P	A	C	I	N	G	
	8	.	3	3	k	H	z

25 kHz: allows input of 25 kHz channels only.

S	P	A	C	I	N	G	
			2	5	k	H	z

A short press of **SET** switches to the next configuration item.



Please remember to enable 8.33 kHz channel selection before flying into areas where 8.33 kHz channels are used.

3.2 DISPLAY – Energy Saving Mode (Automatic display darkening)

In order to minimise power consumption the backlight of the LCD display can be switched off after a selectable time period

With the **VOL/SEL** turn knob the following options can be selected:

always on: no display darkening

D	I	S	P	L	A	Y	
e	v	e	r			o	n

off xxx s: automatic display darkening after xxx seconds after last user interaction (xxx= 10s, 20s, 30s, 60s, 120s)

D	I	S	P	L	A	Y	
o	f	f			1	0	s

Reactivation of the darkened display is done by pressing any key or turning any knob (the action of the key pressed is performed when pressing the key again after the display turned on) or when transmitting.

A short press of **SET** switches to the next configuration item.



This feature should only be used when:

- it can be foreseen that no frequency changes will be required (i.e. when using only limited airspace near one airport, e.g. for circuit pattern training flights), and
- the crew is familiar with the energy saving mode

In all other cases this feature shall be deactivated, in order to prevent the usage of wrong frequencies and to avoid confusion of pilots not aware of the energy saving mode.

Operation and Installation

3.3 PTT SLCT – PTT Button Selection

In the event that two external PTT buttons are wired up, this configuration item can be used to deactivate one PTT button, and the associated microphone(s), from transmitting.

With the **VOL/SEL** rotary knob the following options can be selected:

all mics: both PTT buttons and all microphones are used for transmissions, no matter what PTT button is pressed.

P	T	T		S	L	C	T
a	l	l		m	i	c	s

one mic: according to the PTT button pressed, the associated microphone is activated

P	T	T		S	L	C	T
	o	n	e		m	i	c

left: only the left PTT button and the left microphone(s) are used for transmissions

P	T	T		S	L	C	T
l	e	f	t				

right: only the right PTT button and the right microphone(s) are used for transmissions

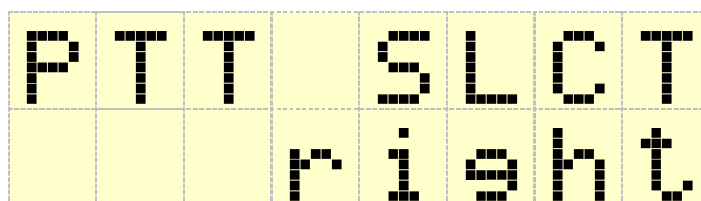

The intercom functionality is not affected by this setting.

A short press of **SET** switches to the next configuration item.



When deactivating one PTT button and microphone for transmissions, e.g. in order to keep passengers from interfering with ATC communication, don't forget to reactivate the co-pilot's PTT at the end of the flight.

3.4 DUOWATCH – Dual-Watch Volume Reduction

By briefly pressing the **SET** button four times, the volume level (“mute”) for reception on the standby frequency (when having dual watch active) will be lowered, and can be controlled by the **VOL/SEL** rotary knob. This allows acoustic distinction between both frequencies.

For further information about the dual watch mode see chapter 2.8.

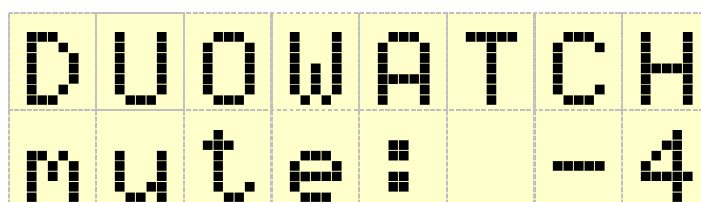

↵ Range - 9 - 0

Minus 9 is the strongest reduction, i.e. the dual watch reception is much quieter.

0 means no reduction, i.e. the dual watch reception is as loud as the reception on the active frequency.

3.5 EXTAUDIO – Behaviour of External Audio Input

The external audio input can be used to feed a monaural audio signal to the amplifier for the headsets/speaker.

An external audio signal can be used for different purposes. E.g. it is possible to check the audio signal of a VOR receiver, to attach a traffic sensor with acoustic output, or to use the external audio input for (monaural) music input.

As these signals have different priorities in comparison to radio receptions, the priority of the external audio input can be configured.

With the **VOL/SEL** rotary knob the following options can be selected:

ever on: The external audio input is always on, even when in radio reception and transmit mode. Use this setting only for very high priority acoustic warnings, e.g. collision warning beep tones.

E	X	T	A	U	D	I	O
e	v	e	r			o	n

auto off: The external audio input is automatically deactivated during transmit mode, or when no external audio activity is sensed.

E	X	T	A	U	D	I	O	
a	u	t	o			o	f	f

Operation and Installation

not RXTX: The external audio input is automatically deactivated during radio reception or transmit mode. This setting does not use the external audio activity sensing, and therefore can introduce noise when no signal source is connected.

E	X	T	A	A	D	I	O
n	o	t		R	x	T	x



Use this setting only when auto off does not react fast enough for very short external audio signals!

A short press of **SET** switches to the next configuration item.

3.6 MIC – Selection Microphone Type

The next option in the configuration menu is the setting of the microphone type.

Selecting the microphone type switches the individual microphone inputs. With the setting "dynamic" the dynamic inputs MIC L dyn and MIC R dyn become active and the input for standard microphones is switched off. With the setting "standard" the inputs for standard microphones MIC L std. and MIC R std become active and the dynamic microphone inputs are deactivated. This avoids noise on unused inputs.

With setting "auto", a standard microphone works on the standard input **or** a dynamic microphone on the dynamic input.

If the dynamic microphone inputs are occupied, these are automatically activated and the standard inputs are switched off. If the dynamic microphones are deactivated via a switch, the standard microphone inputs are automatically activated.

M	I	C	L		T	Y	P
a	u	t	o				

M	I	C	L		T	Y	P
d	y	n	a	m	i	c	

M	I	C	L		T	Y	P
s	t	a	n	d	a	r	d

A short press of **SET** switches to the next configuration item.

3.7 MIC L/R – Microphone Input Sensitivity

Under the menu point “Microphone Input Sensitivity” you can adjust the gain of the microphone input and thus its sensitivity.

The sensitivity can be adjusted with the **VOL/SEL** turn knob. The sensitivity can be adjusted separately for the left and right microphone and for each type.

M	I	C	L		s	t	d
s	e	n	s			0	5

↪ Range 0 – 9

M	I	C	L		d	y	n
s	e	n	s				3

↪ Range 0 – 9

Operation and Installation

M	I	C	R		s	t	d
s	e	n	s			0	5

↩ Range 0 – 9

M	I	C	R		d	y	n
s	e	n	s				3

↩ Range 0 – 9

A short press of **SET** switches to the next configuration item.

3.8 HEAD OUT – Headset Configuration

The menu item HEAD OUT determines whether one headset output is used or whether both headset outputs are used for separate control.

H	E	A	D		O	U	T
o	n	e					

The setting "one" is required when operating the transceiver with an old harness (without extension -S in the cable name). Adjusting the volume of the sidetone during transmission is then carried out via the menu item STL (Sidetone Level) and controls both headphones. The menu item STR is hidden.

H	E	A	D		O	U	T
t	w	o					

The setting "two" is required for the separate setting of the sidetone (STL and STR) of the headphones and requires the separate connection of two headphones. Cable sets with the extension "-S" provide this separate connection.

3.9 AUTO ON – Power-On Behaviour

The last menu point **AUTO ON** configures the power-on behaviour of the radio

With setting "on" the radio is switched on as soon as power is supplied to the unit.

With setting "off" the device remains switched off when power is supplied, no matter in which state it was turned off.

A	U	T	O		O	N	
o	n						

A	U	T	O		O	N	
o	f	f					

3.10 FW / SW – Firmware / Software Version

The firmware and software versions are shown under these menu items. The user cannot change these.

Display Firmware-NF (Example)

F	W		0	1	.	0	0
2	0	0	9	6			

Display Software-Kopf (Example)

S	W		0	1	.	0	0
2	0	0	9	9			

Here a short press of **SET** terminates the configuration menu and the unit returns to the standard view.

Operation and Installation

3.11 Master Reset - Reset to Factory Settings

With the following procedure all configurations are reset to the factory settings. Switch off the device. Press **MEM** and **DW** button simultaneously and switch the unit on with these buttons pressed.

After the start display the following display appears

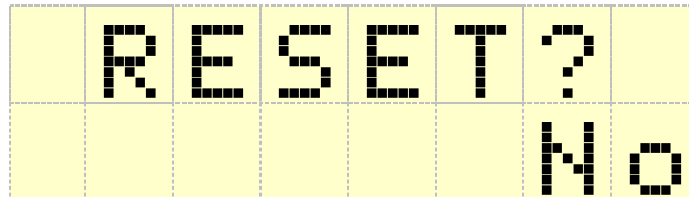

Select Reset – Yes with the **VOL/SEL** turn knob

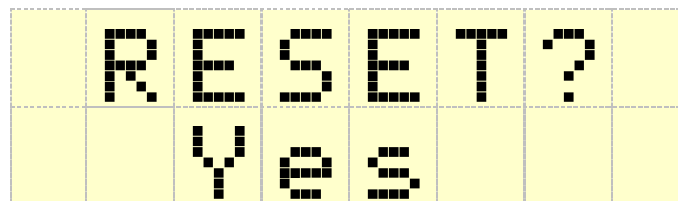

The reset process is activated by pressing the SET button. The reset is confirmed with "DONE" and the transceiver automatically restarted

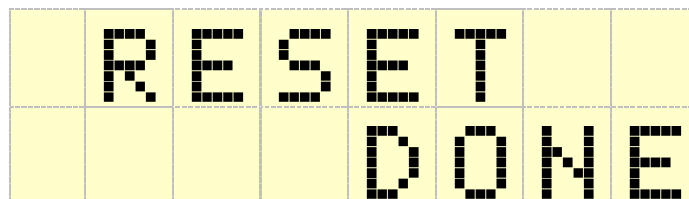

The reset process is activated by pressing the SET button. The reset is confirmed with "DONE" and the transceiver automatically restarted

3.12 Adapter Operation

If the ATR833S is operated with an adapter for an older cable set, this adapter is automatically detected and the device is set into adapter mode. In adapter mode, the following settings are made automatically:

1. PTT Select is set to "all mics" because with "single mic" setting it might be that one microphone is not working. The "PTT Select" selection is therefore hidden in adapter mode.
2. Adjusting the volume of the sidetone during transmission is done via the menu STL and controls both headphones. The menu item STR is hidden. The intercom volume is adjusted via the INT setting and controls both headsets.

3.13 Overview Configuration Menu (Setup)

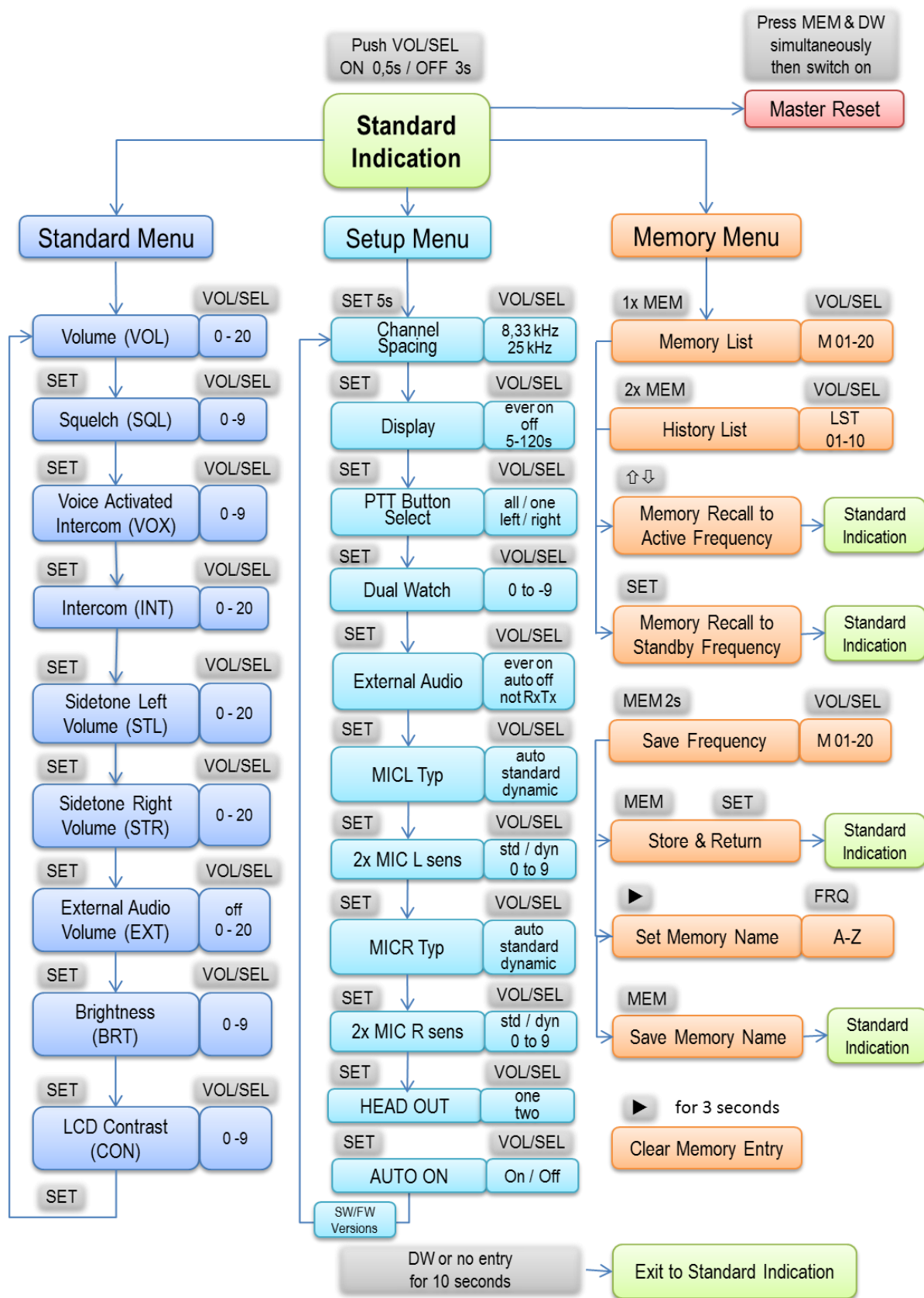

4 INSTALLATION

4.1 Advice and Tips

The following suggestions should be considered before installing the unit.

The assigned installation company shall be able to perform the wiring. For diagrams refer to section 4.7 Wiring

4.2 Telecommunication Data

The following data may be required when applying for the aircraft radio station license:

Manufacturer:	f.u.n.k.e. AVIONICS GmbH
Type Designation:	ATR833S
EASA Number:	EASA.21O.10060316
Transmitter Power Output:	6 Watt
Frequency:	118,000 – 136,975 MHz
Emission Designator:	6k00A3E for 25khz channel spacing 5k00A3E for 8,33kHz channel spacing

4.3 Scope of Delivery

Part No.	Description
ATR833S	ATR833S – VHF communication transceiver
ZUB3	4x mounting screw M4x8 Fastening screw for panels with thickness up to 5 mm
SSATR2	Connector (Only if no cable set was ordered)
01.142.010.71e	User Manual „Operation and Installation“
	EASA Form 1

4.4 Unpacking and Inspection of the Equipment

Carefully unpack the equipment. Damage due to transportation must be reported to the shipping company immediately. Save the shipping container and all packing materials to substantiate your claim.



Please use the original packing material for storage and shipping.

4.5 Mounting

- In cooperation with a maintenance shop, the location of the radio in the cockpit and kind of the installation should be specified. The maintenance shop could supply all cables but suitable sets of cables are available also from f.u.n.k.e. AVIONICS GmbH.
- Select a position away from heat sources. Care for adequate convection cooling.
- Leave sufficient space for the installation of cables and connectors.
- Avoid sharp bends and wiring close to control cables.
- Leave sufficient lead length for inspection or repair of the wiring of the connector.
- Bend the harness at the rear connectors such as to inhibit water droplets (formed due to condensation) from collecting inside the connector.
- The equipment is fixed from the front with four 4x8mm screws into a 2¼ " cut-out.
- For mounting details / drawing refer to chapter 4.11.2

Operation and Installation

4.6 Equipment Connections

One 25 pin D-SUB miniature connector includes all electrical connections, except for the antenna.

	The (+UB)-wire (PWR – Pin 11/12) has to be protected by a circuit breaker (4 Amp. slow-blow)!
---	---

4.6.1 Microphone Connection

The standard microphone inputs provide phantom power of 9V. The sensitivity can be set in the configuration menu (see chapter 3.7).

Standard microphones (headset) and dynamic microphones (hand / gooseneck) can be connected at the same time. With setting MIC type auto, the dynamic microphone connection has priority over the standard microphone.

4.6.2 Headset-Connection

Two headsets may be connected in parallel per input. In this case the total impedance shall not be less than 100 Ω .

4.6.3 Audio-Input

The external audio input can be used for the input of warning tones or music etc. In order to avoid disturbances, while this input is not used, the respective wire needs to be short-circuited.

Cable sets available from f.u.n.k.e. AVIONICS already have the external audio-input short-circuited with a blind plug. This blind plug can be easily removed in order to use the external audio input.

	If the external input is not used it needs to be short-circuited with GND, in order to avoid the pickup of electrical noise.
---	--

Operation and Installation

4.6.4 Operation with Cable Adapter

If the radio is connected to a pre-installed cable set via a cable adapter, both headphones are connected to the left headphone output. In this case a separate sidetone setting is not possible. The device automatically detects the cable adapter and adjusts the settings in the standard menu accordingly.

The menu item **STR** is omitted and via **STL** the sidetone can be set in transmit mode for both headphone connections.

The **INT** menu item controls the intercom volume for both headphones.

4.7 Wiring

4.7.1 Cable Cross Section

The electric cables used must be approved for aircraft installation.

Power Supply (Power, GND): AWG18 (0.96 mm²)

Signals: AWG22 (0.38 mm²)

4.7.2 Connector – Pin Allocation

The ATR833S has a 25 pole D-SUB connector. The pin allocation is given in the following diagram:

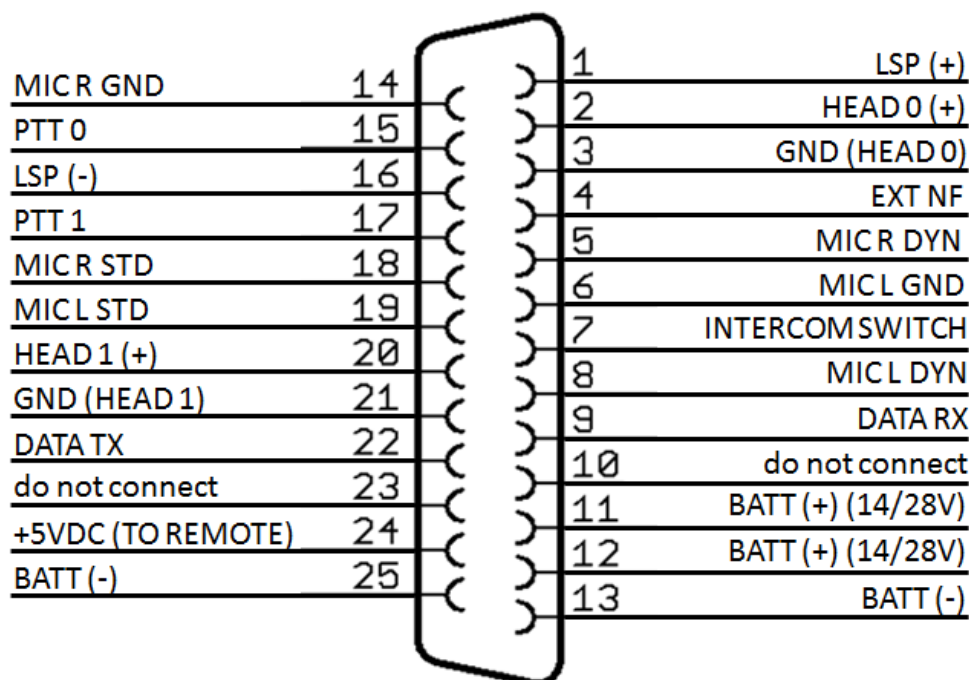

D-SUB Connector 25 Pin Female
seen from solder side

Operation and Installation

Pin	Names	Functionality
1	LSP(+)	Output external Loudspeaker Positive
2	HEAD-0 (+)	Output Headset-Speaker Positive
3	GND (HEAD-0)	Output Headset-Speaker Negative
4	EXT-NF	Input external Audio-Signal
5	MIC R DYN	Input Microphone Right Dynamic
6	MIC L GND	Input Microphone Left Ground
7	INTERCOM SWITCH	Intercom Activation Switch (connect to ground for Intercom activation)
8	MIC L DYN	Input Microphone Left Dynamic
9	DATA-RX	RS232 Receive (for Remote Control)
10	do not connect	Pin 10 is used by adapters for device identification
11	+14 / +28V-PWR	Input Power Supply +12V
12	+14 / +28V-PWR	Input Power Supply +12V
13	BATT (-)	Ground Side of Power Supply
14	MIC R GND	Input Microphone Right Ground
15	PTT-0	Push-to-Talk 0 (connect to ground for transmitting)
16	LSP(-)	Output external Loudspeaker Negative (Not identical to ground!)
17	PTT-1	Push-to-Talk 1 (connect to ground for transmitting)
18	MIC R STD	Input Microphone Right (Headset 1)
19	MIC L STD	Input Microphone Left (Headset 0)
20	HEAD 1 (+)	Output 1 Headset-Speaker Positive
21	GND (HEAD 1)	Output 1 Headset-Speaker Negative
22	DATA-TX	RS232 TX (for Remote Control)
23	N/A	do not connect
24	+5VDC OUT	5VDC Power Supply for Remote Control
25	BATT (-)	Ground Side of Power Supply

4.7.3 Wiring with Cable Harness BSKS833x-S

4.7.3.1 Overview / Variants of cable sets

Five different cable sets are available for a wide range of applications

BSKS833S-S	Basic cable-set for single-seater
BSKS833D-S	Basic cable-set for double-seater
BSKS833OE-S	Cable-set for double seats (powered aircraft) with open ends
BSKS833GLS-S	Cable-set for single-seater (glider) with open ends
BSKS833GLD-S	Cable-set for double-seater (glider) with open ends

You will find a detailed description of the cable variants, such as the corresponding cable diagram, in document Doc. No. 01.14x.050.50 on our homepage under

www.funkeavionics.de Service / info download / radios

4.7.3.2 Connector D-SUB DE-9 Female for Remote Control

This connector contains the serial interface and the power supplies for a remote control unit or Bluetooth adapter.

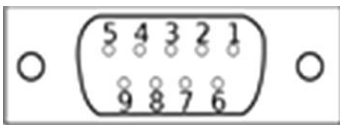
Connector for the Remote Control in the cable harness BSKS833D-S View from aircraft's side		1: not connected 2: Data TX 3: Data RX 8: +5VDC 5: GND shielding
---	--	--

The remote interface of the ATR833S is a RX-TX-only connection with true RS232 voltage levels, with 9600 baud, 8 data bits, no parity, 1 stop bit, no handshake.

All messages start with the two byte sequence 0x02 (STX) and 0x72 ('r') for synchronization, followed by a message identification-byte and different numbers of data bytes.

Operation and Installation

Byte #	Value	Description
1	0x02 (STX)	Synchronization
2	0x72 ('r')	Synchronization
3	<i>id</i>	<i>id</i> of message
4...3+n	<i>n data bytes</i>	depending on message
4+n	<i>checksum</i>	XOR of bytes #2 ... #3+n, i.e. excluding the STX and the checksum itself

Byte Stuffing

When the STX byte (0x02) occurs in the data bytes of a message, this byte will be doubled to distinguish it from STX. The checksum includes then both 0x02 values.

The message ID 0x12 Set Standby Frequency contains two data bytes:

Data Byte #	Description	Possible Values / Remarks
1	MHz	118...136
2	kHz / 5	0...198 (corresponds to 0...990 kHz)

The standby frequency and the active frequency can also be adjusted by Garmin devices. The protocol corresponds to the Garmin SL40.

4.7.3.3 Connector EXT-NF for Monaural Audio Input

This connector is used for the input of monaural audio signals. It can be used e.g. for acoustic traffic warnings, for radio navigation receiver's acoustic identifiers, or for input of music into the headsets.

The priority of radio reception in relation to this input can be configured as described in section 3.5.

4.8 Antenna

4.8.1 Antenna Selection

- A VHF-COM-Antenna with an impedance of 50 Ohm is required.
- Choose an antenna type approved for the aircraft and the mounting location.
- The antenna should be located far away from ELT-antennas and other VHF antennas.
- Specified features depend on proper installation of the antenna.

4.8.2 Installation Recommendation

- Take note of the antenna manufacturer's instructions.
- The metallic contact between the aircraft surface and antenna-GND must be very good. On non-metallic airplanes a metal foil (min. 80 cm x 80 cm) shall be used as electrical counterweight on the inside of the fuselage.
- To avoid a mutual interference of the radios, the antenna isolation between a voice transmission and a navigation antenna as well as between double COM antennas should be as large as possible. A distance of 2 meters usually is sufficient.
- Assemble the antenna in a vertical position on or under the fuselage that it is as far distant as possible from all protruding parts (propeller, chassis, vertical stabilizer)
- For glider installation the internal antenna installed by the manufacturer should be used.
- The SWR shall not exceed 3:1.



The HF antenna wire must not be included in any other cable sets, for example power supply or microphone. It must also not be placed together with other antenna wires, for example NAV or Transponder.

4.9 Microphone / Intercom settings

The settings of MIC and VOX values are essential for Intercom. The respective configuration options are described in section 0 (VOX=threshold level) and section 3.6 (MIC input sensitivity)

If the VOX automatic is deactivated with VOX=0 then the intercom is activated using the intercom switch (not PTT), which connects PIN 7 (intercom) of the equipment connector to GND.

For operation with VOX activated PIN 7 has to be connected to GND permanently. Transmission only operates when PTT is pressed.

The suppression of background noise is only possible when using differential microphones, as they are usual with modern headsets. Normal electret microphones are not suitable.

4.10 Post-Installation Check

	A certified maintenance shop must verify proper operation of the VHF Transceiver System.
---	--

When installation is completed all steering and control functions of the aircraft are to be examined, in order to exclude disturbances by the wiring. The SWR shall not exceed 3:1.

Furthermore a test flight is recommended in order to guarantee the proper in-flight operation of the radio; note the following:

- In a flight altitude of at least 2000 ft contact a ground station in a distance of at least 50 km (30 nautical miles).
- Pay attention to unusual electrical interference.
- If possible, perform the radio test on frequencies within the upper and lower VHF communication frequency range

4.11 Drawings

4.11.1 Dimensions

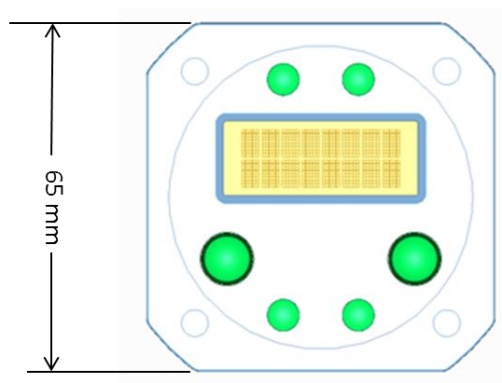
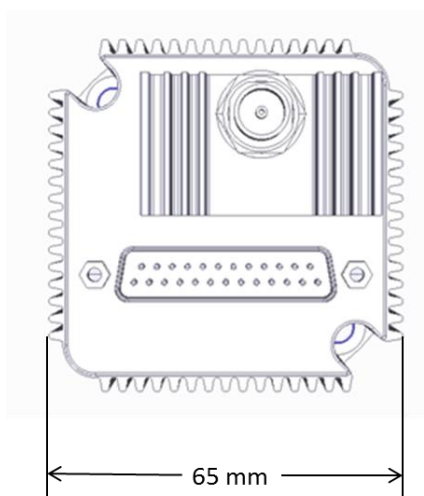
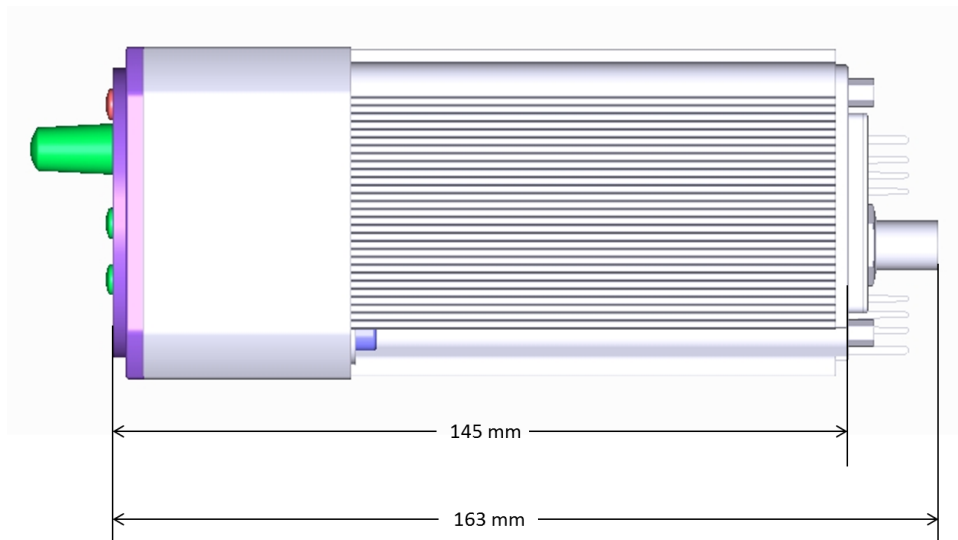

Operation and Installation

4.11.2 Mounting Advice

For mounting in panels with a thickness of up to 5 mm use the fastening screw M4x8 (ZUB3).

Dimensions in connector area

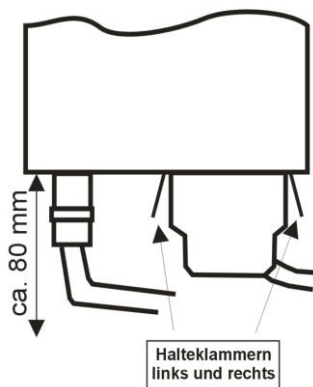

Dimensions of panel cut-out

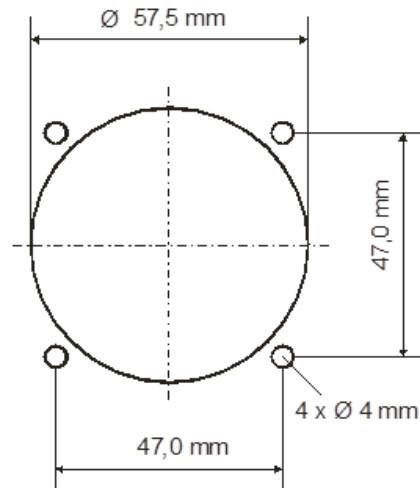

	<p>No screws may be turned in more than max. 10 mm into the device – even if no hard limit is noticeable!</p> <p>Caution: If a screw is used that is too long it is likely to damage the electronics inside the radio if fully screwed in.</p>
---	--

	<p>The D-Sub-Connector (plug) has to be clamped with both spring locks. It is recommended to secure them additionally with a cable tie.</p>
---	---

5 APPENDIX

5.1 Frequency/Channel-Plan

In the following table examples for operating and displayed frequencies in the range between 118.000 ... 118.100 MHz are given. This table can be continued to 136.975 MHz following the same scheme.

Operating Frequency (MHz)	Channel Width (kHz)	Displayed Frequency in	Operating Frequency (MHz)
118.0000	25	118.000	118.000
118.0000	8.33		118.005
118.0083	8.33		118.010
118.0166	8.33		118.015
118.0250	25	118.025	118.025
118.0250	8.33		118.030
118.0333	8.33		118.035
118.0416	8.33		118.040
118.0500	25	118.050	118.050
118.0500	8.33		118.055
118.0583	8.33		118.060
118.0666	8.33		118.065
118.0750	25	118.075	118.075
118.0750	8.33		118.080
118.0833	8.33		118.085
118.0916	8.33		118.090
118.1000	25	118.100	118.100
118.1000	8.33		118.105
etc.	etc.	etc.	etc.

5.2 Technical Data

GENERAL	
COMPLIANCE	ETSO-2C169a, ED23C Transceiver Class 4, 6 Receiver Class C, E, H1 & H2 ETSO 2C128
DIMENSIONS	Height: 65 mm (2,56 in) Width: 65 mm (2,56 in) Depth: 163 mm (6,42 in)
WEIGHT	0,38 kg (0,84 lbs)
MOUNTING	Panel mounted
TEMPERATURE RANGES OPERATION STORAGE	-20°C ... +55°C, 30 min bei +70°C -55°C .. +85°C
MAX. HEIGHT	35.000ft
VIBRATION	DO-160D, Cat. S, Vibration Curve M
HUMIDITY	RTCA DO-160D, Cat. A
SHOCK	6 G operational 20 G crash
RTCA DO-160F ENV.CAT.	[C1Z] CAB [SM] XXXXXX Z B(XX) AB [AC] [TT] M [XXXXX] XXAC
POWER SUPPLY	11.0 – 30.0 VDC nominal 9.0 VDC Emergency operation Transmitter: max. 2,5A Receiver: 0,2A (Standby), max. 0,5A Audio power amplifier: up to 1A below nominal voltage < 11 VDC <input type="checkbox"/> reduced transmitting power
POWER CONSUMPTION	Standby: 2,8W, Transmit 35W
FUSE	external fuse required: 4 A, slow-blow
FREQUENCY RANGE	118,000 MHz .. 136,975 MHz
FREQUENCY STABILITY	±5 ppm at -20 °C .. + 55 °C
COMPASS-SAFE DISTANCE	30 cm
INTERCOM-INPUT	Microphone inputs are connected to the intercom input. 100 mVRMS at the microphone input produce 0,5W output power at the headphone (300Ω).
NF (AUDIO) - INPUT	1V / 600Ω
TRANSMITTER	
POWER OUTPUT	6 W (nominal) 4 W (minimum)
HARMONIC DISTORTION	< 10 % at 70 % Modulation
SIDETONE OUTPUT	>0,5 W at 300Ω (headphone output)

Operation and Installation

MICROPHONE INPUTS	2 Inputs for standard or dynamic microphones with automatic detection of the microphone type Standard: 50mV-2V at 100Ω Dynamic: 5mV _{pp} – 10mV _{pp}
HARMONIC CONTENT	>60 dBc
MODULATION-FIDELITY	Deviation <6dB von 350-2500kHz
CARRIER NOISE LEVEL	>35 dB at 70% modulation
UNWANTED FREQUENCY-MODULATION	<1kHz at m=70% / 1kHz
DUTY CYCLE	capable of continuous transmission, automatic interrupt after 35 seconds
RECEIVER	
SENSITIVITY	-98 dBm (>6 dB S+N/N, m = 30 % / 1 kHz)
BANDWIDTH / 25 kHz	-6 dB- bandwidth > ±8.0 kHz
BANDWIDTH / 8.33 kHz	-6 dB- bandwidth > ±2.78 kHz
SELECTIVITY (channel spacing 25 kHz)	-40 dB- bandwidth < ±17.0 kHz -60 dB- bandwidth < ±25.0 kHz
SELECTIVITY (channel spacing 8.33 kHz)	-60 dB-bandwidth < ±7.37 kHz
NF-OUTPUT	≥4 W an 4 Ω (Loudspeaker)
AGC CHARACTERISTICS	AF output deviation < 6 dB from 10 μV to 10 mV
SQUELCH	automatic Squelch (adjustable)
SPURIOUS RESPONSES	> 80 dB
DISTORTION (350...2500Hz)	<25% at rated power (85% / -33dBm) / <10% at 10dB below rated power (70% / -33dBm)

5.3 Environmental Conditions

Characteristic DO-160F	Section	Cat	Condition
TEMPERATURE / ALTITUDE	4.0	C1	
LOW GROUND SURVIVAL TEMPERATURE	4.5.1		- 55°C
LOW OPERATING TEMPERATURE	4.5.1		- 20°C
HIGH GROUND SURVIVAL TEMPERATURE	4.5.2		+ 85°C
HIGH SHORT-TIME OPERATING TEMPERATURE	4.5.2		+ 70°C
HIGH OPERATING	4.5.3		+ 55°C

Operation and Installation

Characteristic DO-160F	Section	Cat	Condition
TEMPERATURE			
IN-FLIGHT LOSS OF COOLING	4.5.4	Z	No auxiliary cooling required
ALTITUDE	4.6.1	C1	35 000 ft
TEMPERATURE VARIATION	5.0	C	2°C change rate minimum per minute
HUMIDITY	6.0	A	
SHOCK	7.0	B	6 G operational shocks (11ms) 20 G Crash Safety Test Type R in all 6 directions (11ms)
VIBRATION	8.0	S	Vibration Curve M
EXPLOSION PROOFNESS	9.0	X	No test required
WATER PROOFNESS	10.0	X	No test required
FLUIDS SUSCEPTIBILITIES	11.0	X	No test required
SAND AND DUST	12.0	X	No test required
FUNGUS RESISTANCE	13.0	X	No test required
SALT SPRAY	14.0	X	No test required
MAGNETIC EFFECT	15.0	Z	< 0,3 m Compass Safe Distance
POWER INPUT (DC)	16.0	B	
VOLTAGE SPIKE CONDUCTED	17.0	A	
AUDIO FREQUENCY CONDUCTED SUSCEPTIBILITY	18.0	B	
INDUCED SIGNAL SUSCEPTIBILITY	19.0	AC	
RADIO FREQUENCY SUSCEPTIBILITY	20.0	T	
EMISSION OF RF ENERGY	21.0	M	
LIGHTNING INDUCED TRANSIENT SUSCEPTIBILITY	22.0	X..	No ED23 test, not required
LIGHTNING DIRECT EFFECTS	23.0	X	No test required
ICING	24.0	X	No test required
ELECTROSTATIC DISCHARGE (ESD)	25.0	A	
FIRE, FLAMMABILITY	26.0	C	

f.u.n.k.e.

AVIONICS GMBH

f.u.n.k.e. AVIONICS GmbH

Heinz-Strachowitz-Str. 4
DE-86807 Buchloe
Germany

phone.: +49-8241 80066 0

fax.: +49-8241 80066 99

E-mail:

service@funkeavionics.de

www.funkeavionics.de